

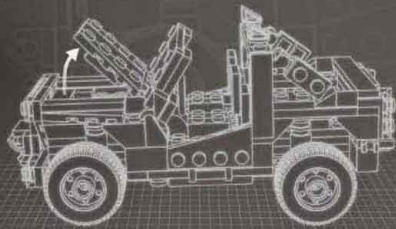

Complexity 
Functions 
Pieces 

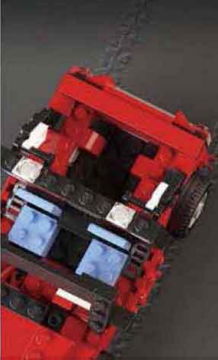
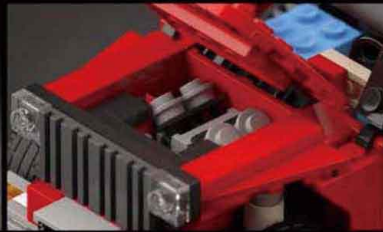

OFF-ROADER

Design notes: wide wheelbase, high clearance, exposed shock absorbers, front-bumper winch, spotlights

Technical specifications:

Dimensions (l x w x h): 20 x 10 x 10 studs

Wheelbase: 11 studs

Axle width front/rear: 10/10 studs

Features: hinged hood, V4 engine, rear accessory clips



1

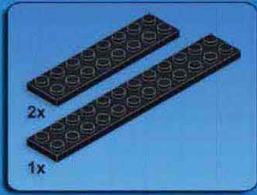

2

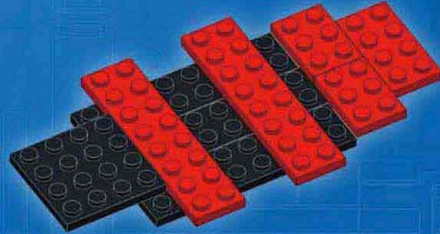
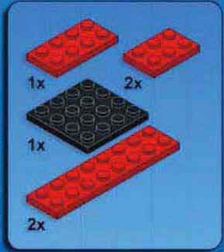

3

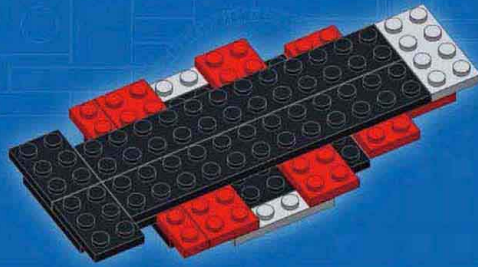
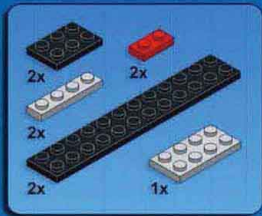



4

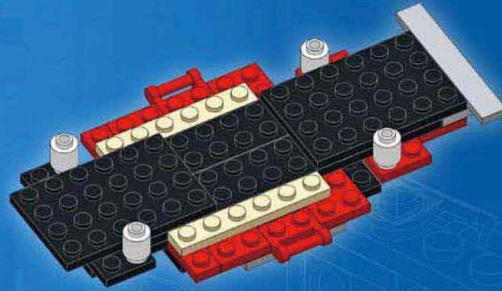

5

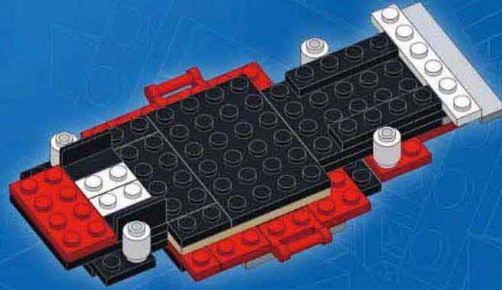
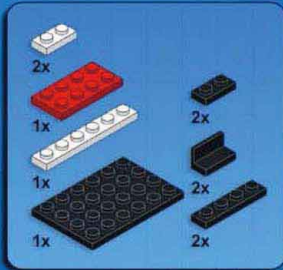

6

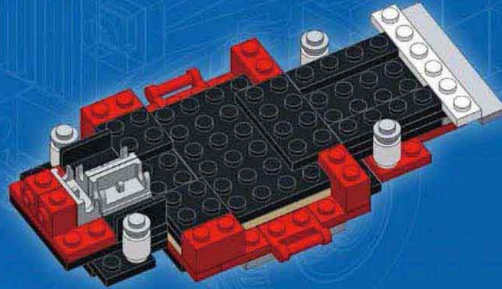
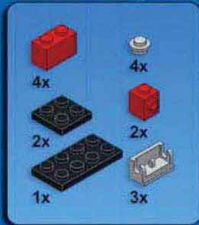



7

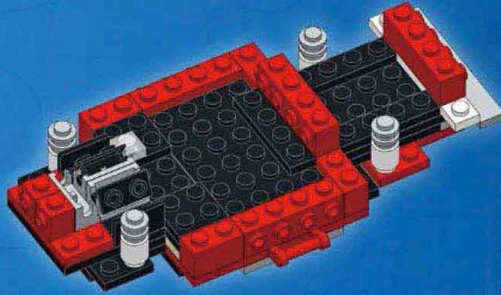
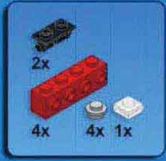

8

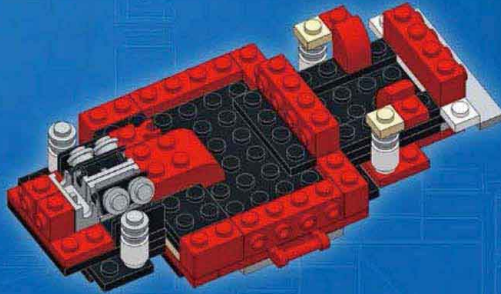
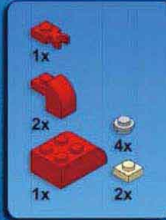

9

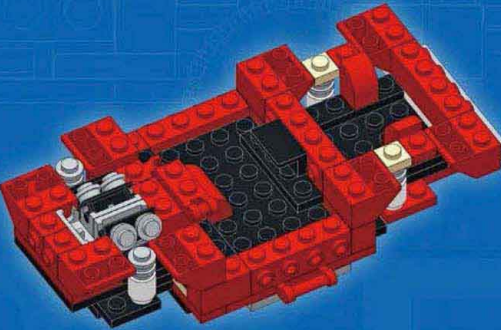
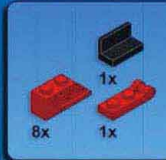

10

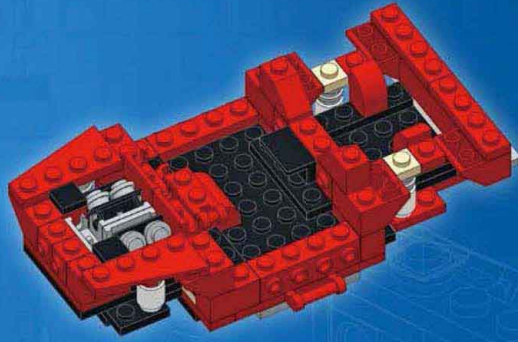
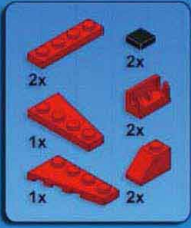

11

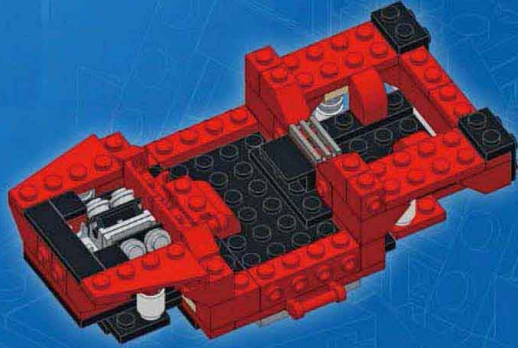
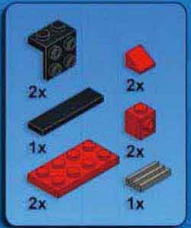

12

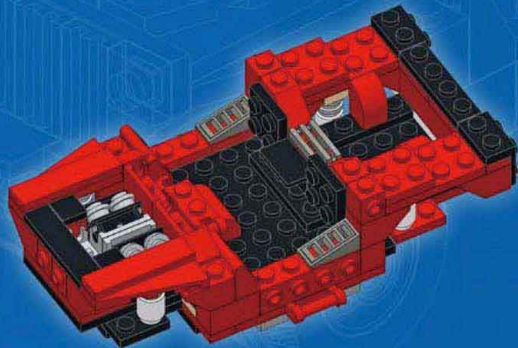
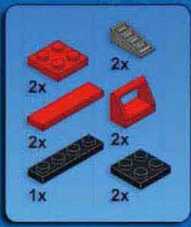



13

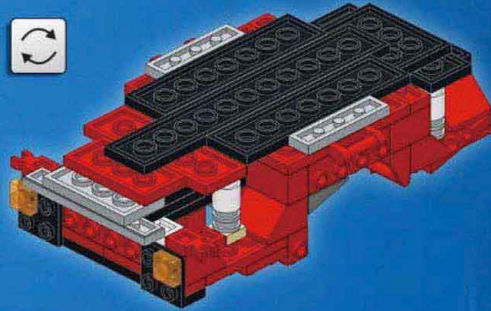

14

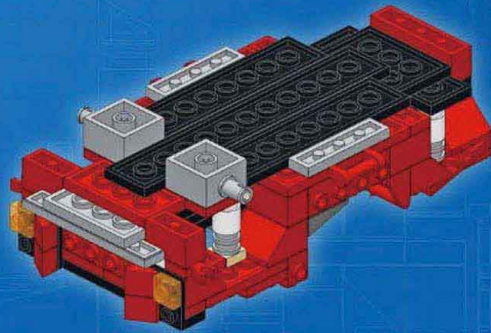
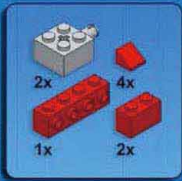

15

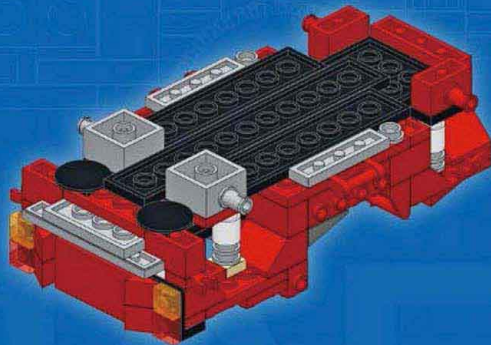
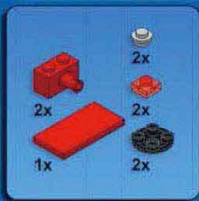



16

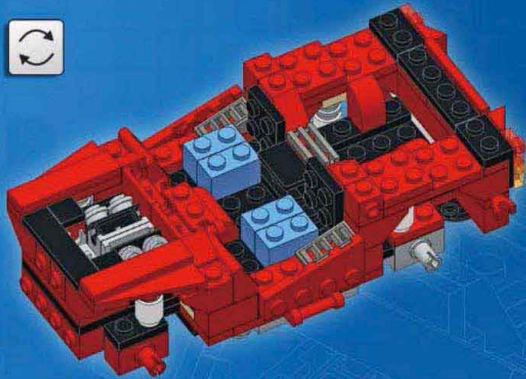
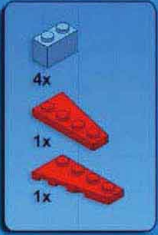

17

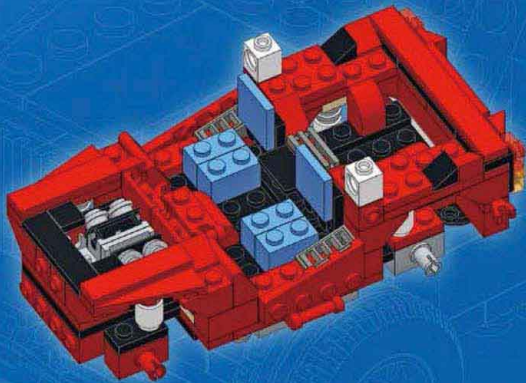
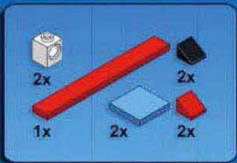

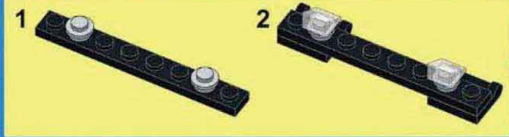

18

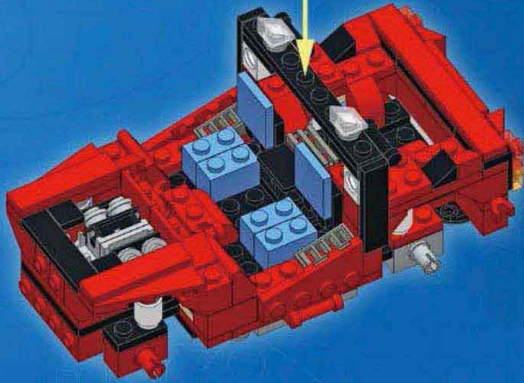
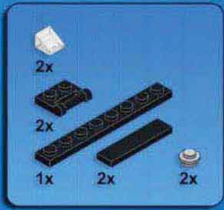

19

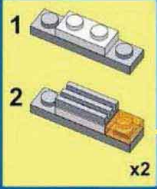
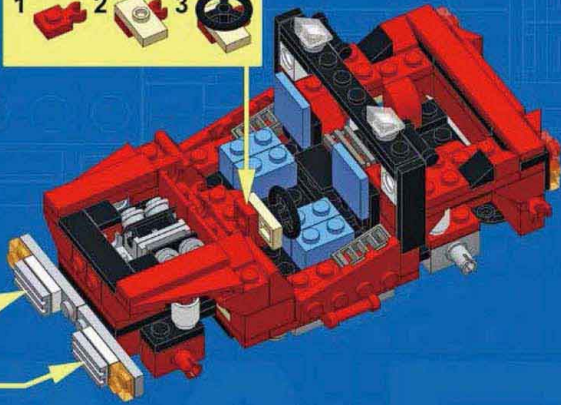
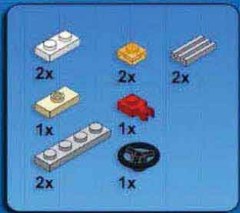



20

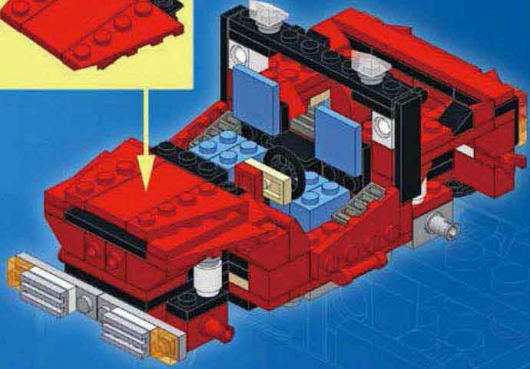
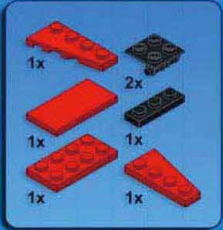
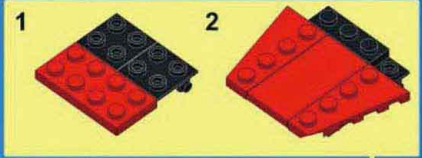

21

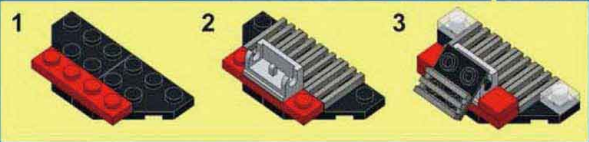
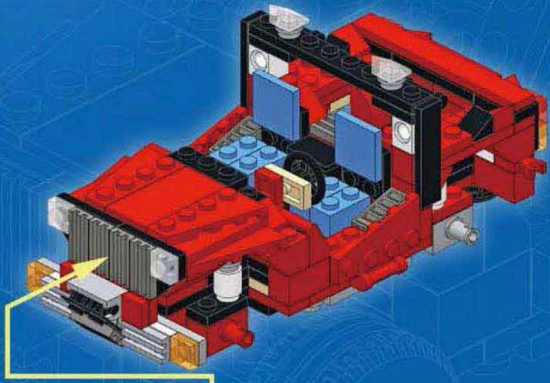
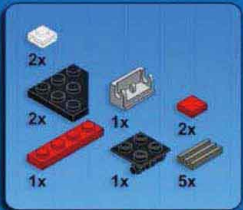

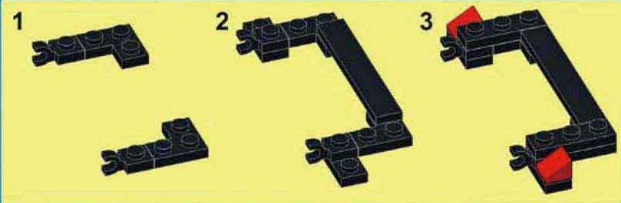

22

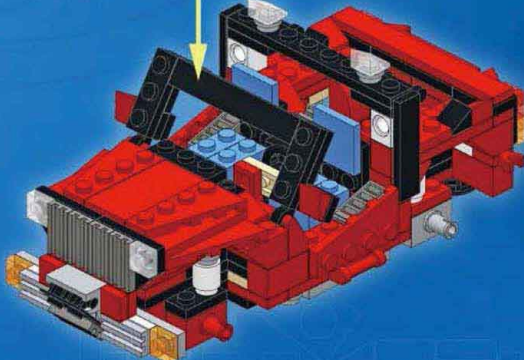
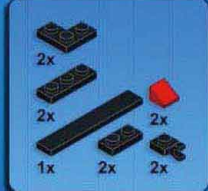

23

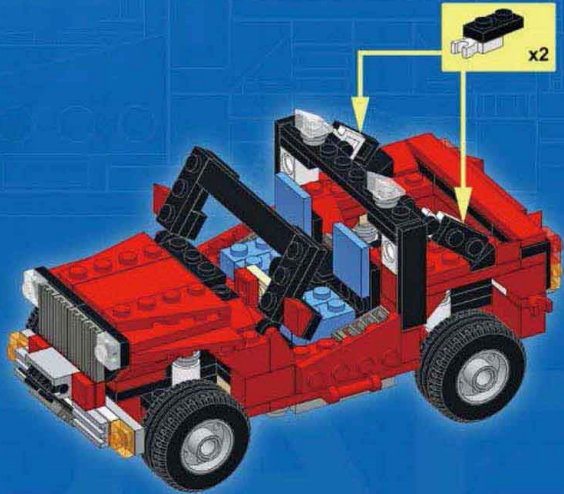



Complexity
Functions 
Pieces 

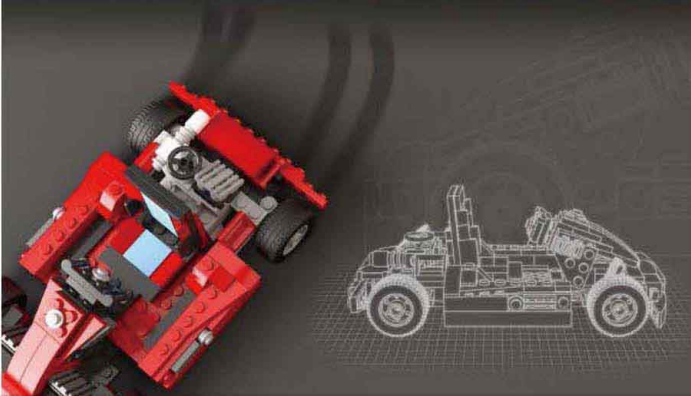

GO-KART

Design notes: wide and low chassis, single-cylinder engine, large seat, small wheels, gas and brake pedals

Technical specifications:

Dimensions (l x w x h): 21 x 12 x 9 studs

Wheelbase: 14 studs

Axle width front/rear: 12/12 studs



1

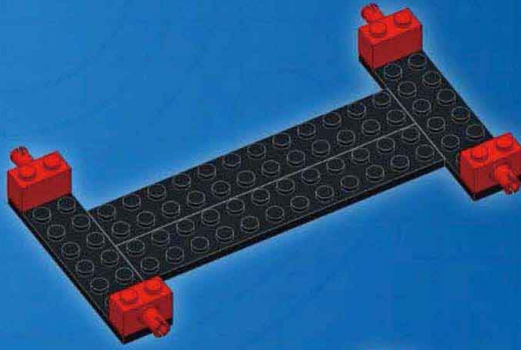
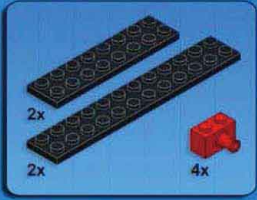

2

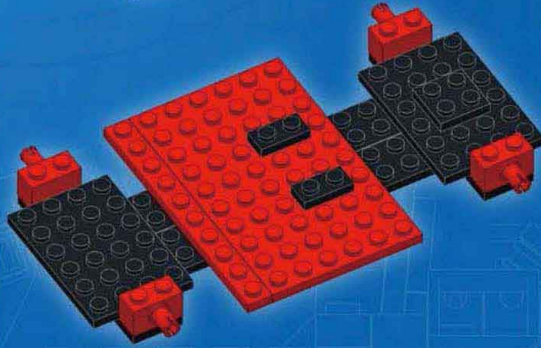
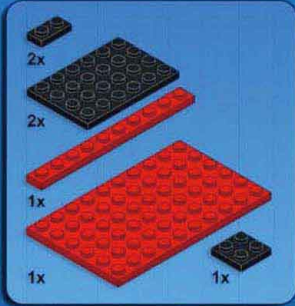

3

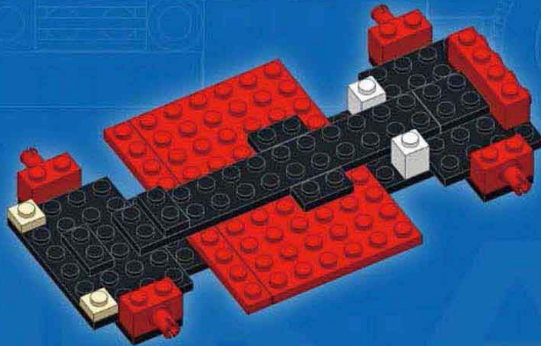
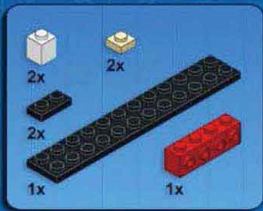

4

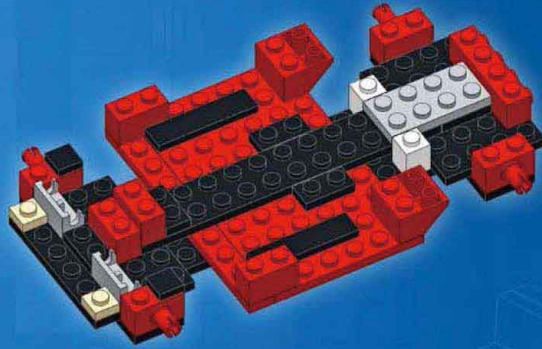

5

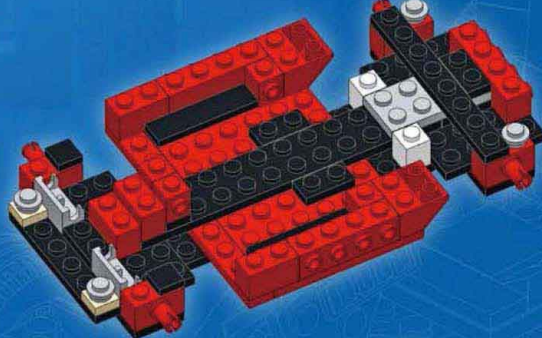
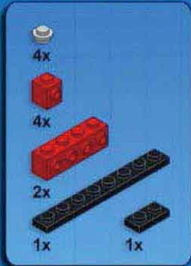

6

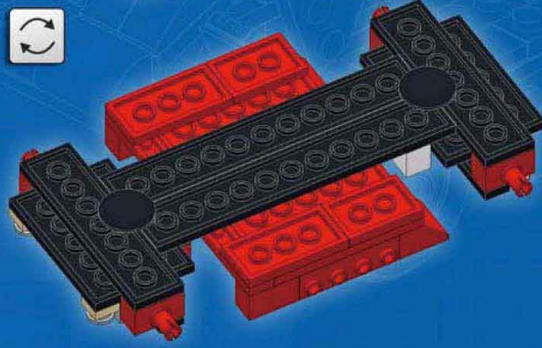
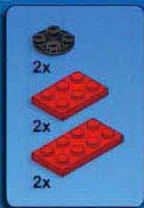

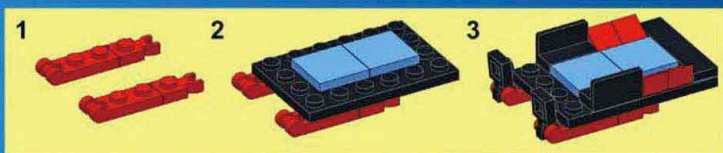

7

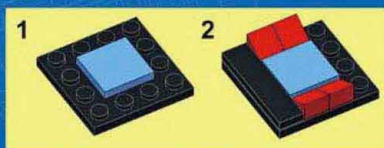
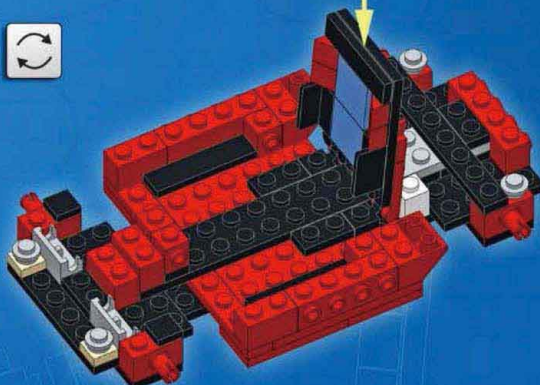

8

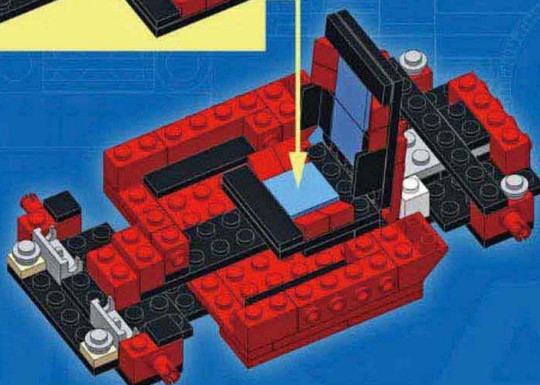
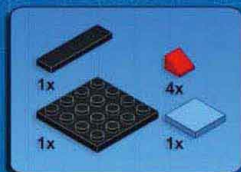

9

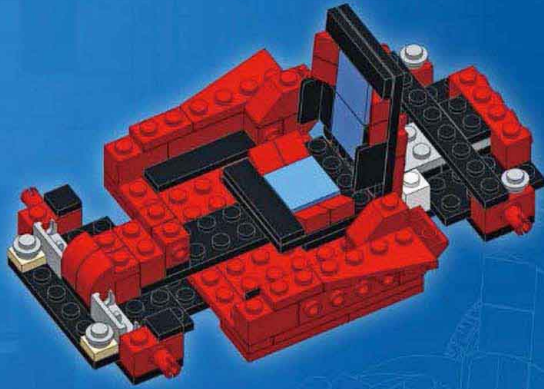
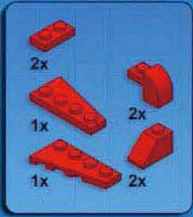

10

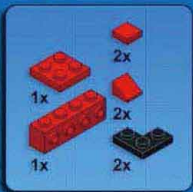



11

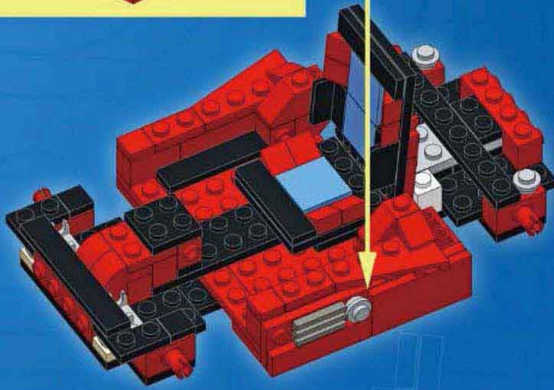
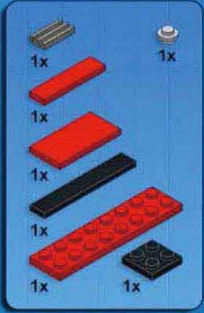
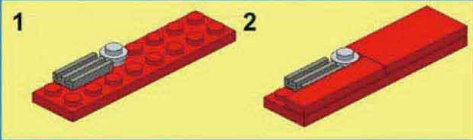

12

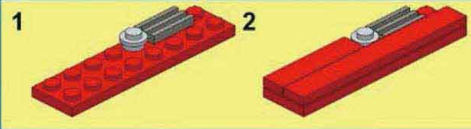
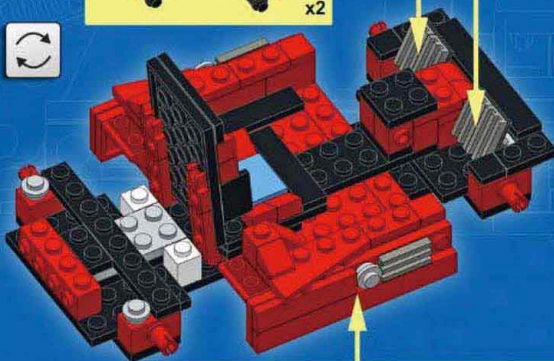
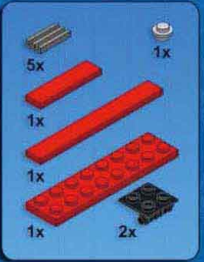

13

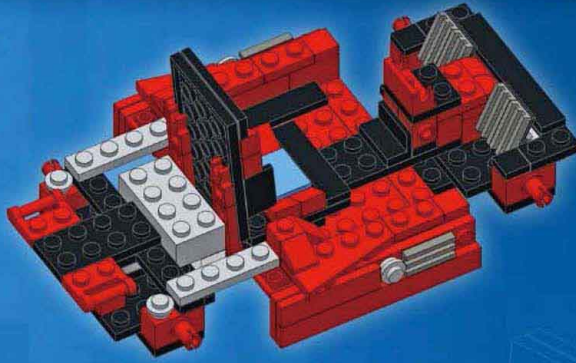
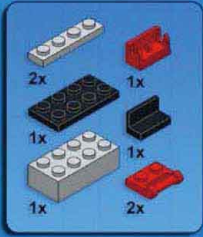

14

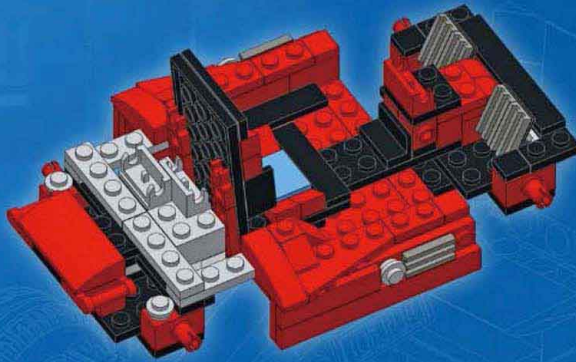
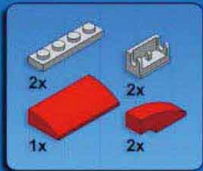

15

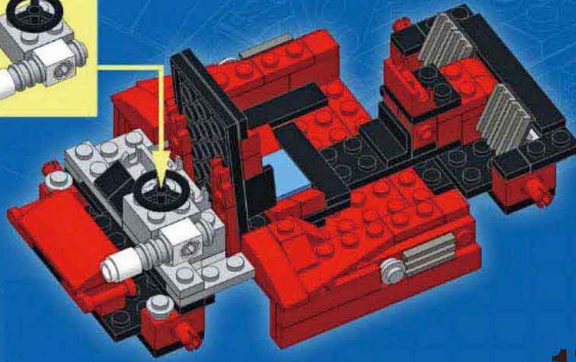



16

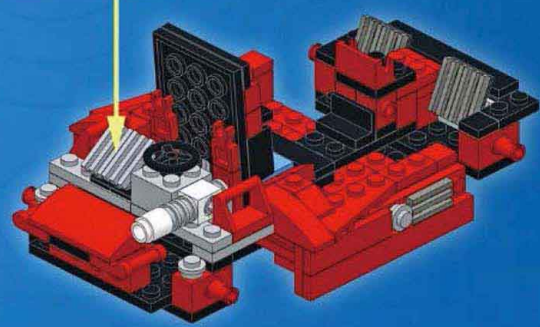

17

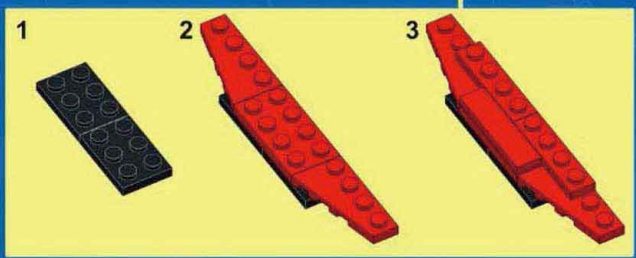
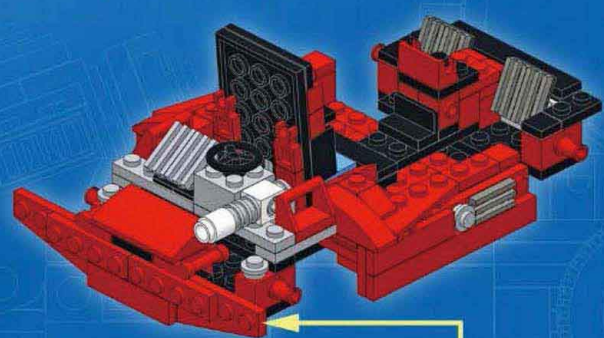
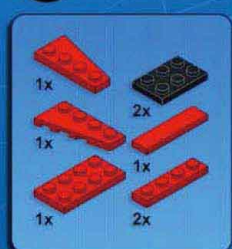

18



18

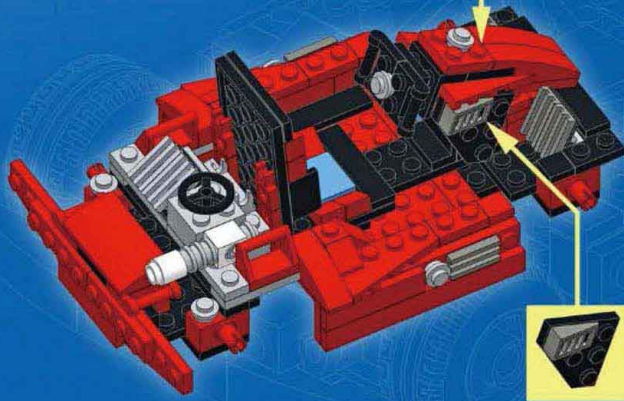
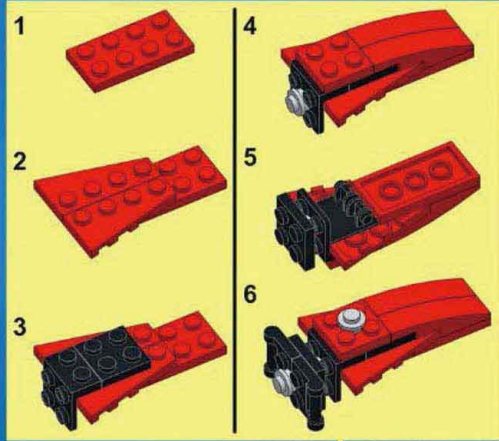
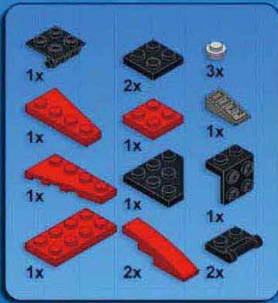



19



- 2x
- 2x
- 2x
- 1x
- 1x

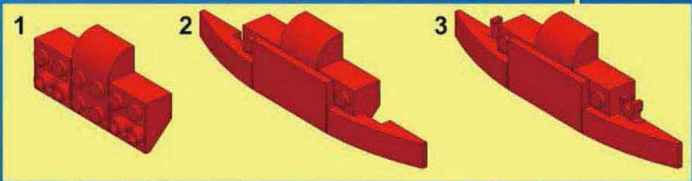

20

- 1x
- 1x
- 4x
- 4x

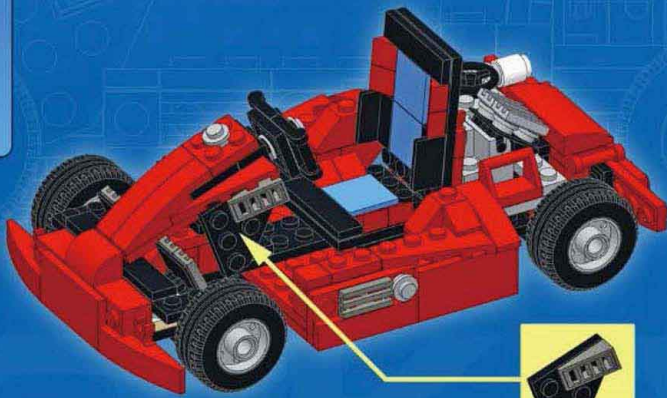



Complexity 
Functions 
Pieces 

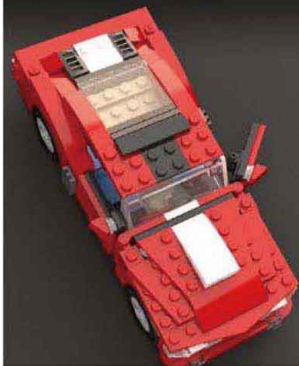
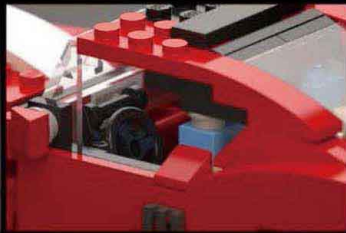

MUSCLE CAR

Design notes: fastback body design, hood scoop, exposed exhaust pipes

Technical specifications:
Dimensions (l x w x h): 21 x 10 x 8 studs
Wheelbase: 12 studs
Axle width front/rear: 8/8 studs

Features: opening doors

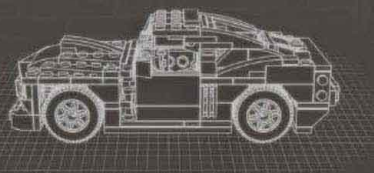



1

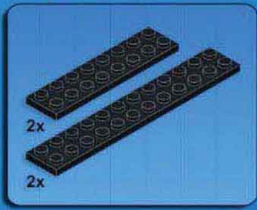

2

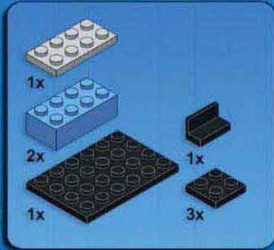

3

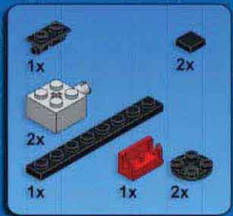



4

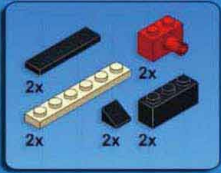

5

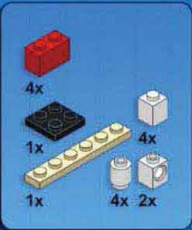

6

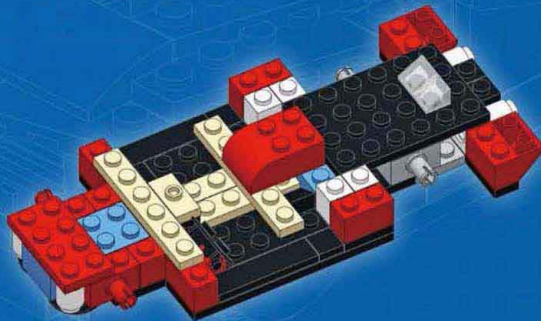
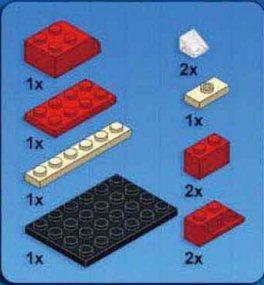



7

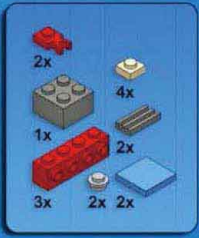

8

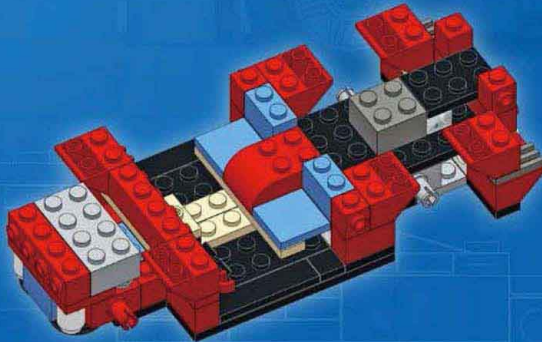
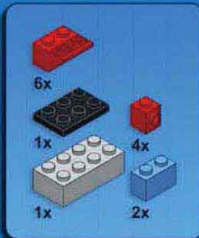

9

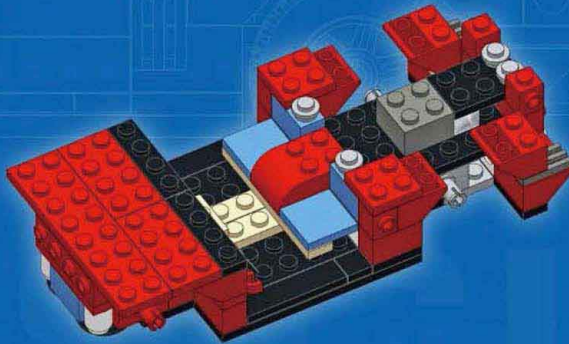
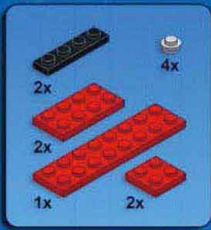

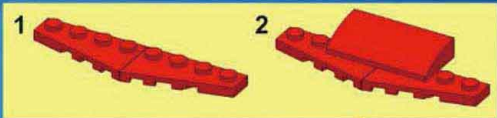

10

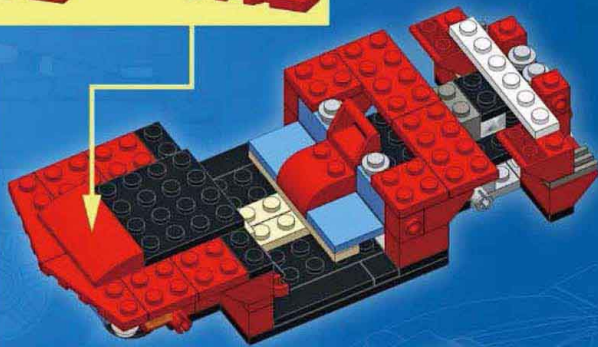
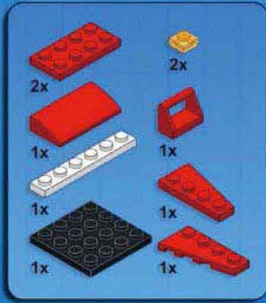

11

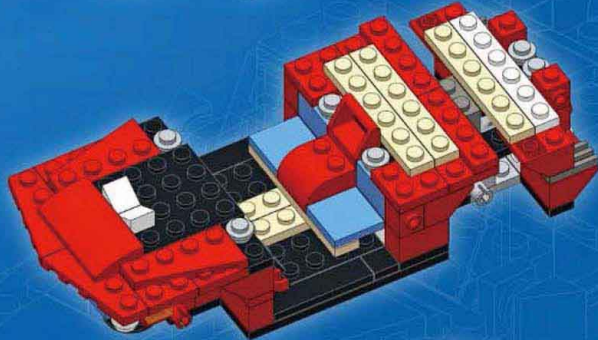
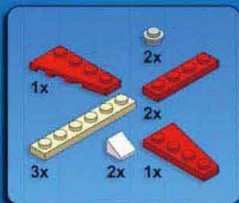

12

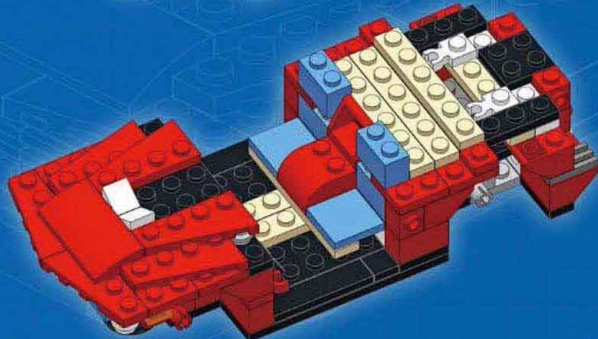
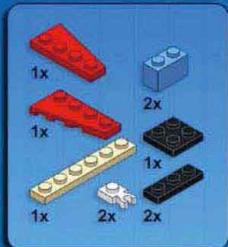



13

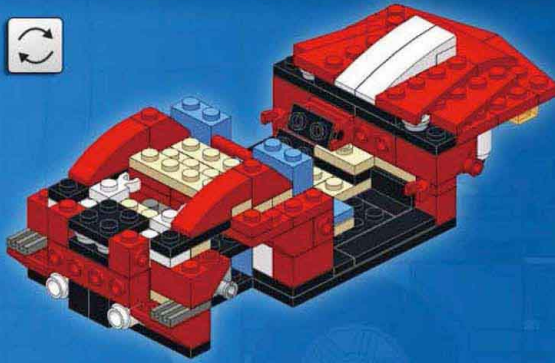
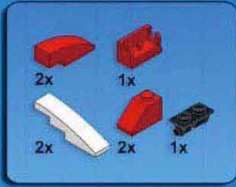

14

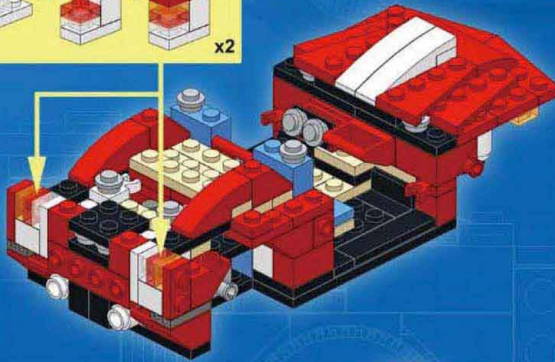
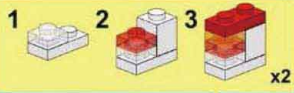

15

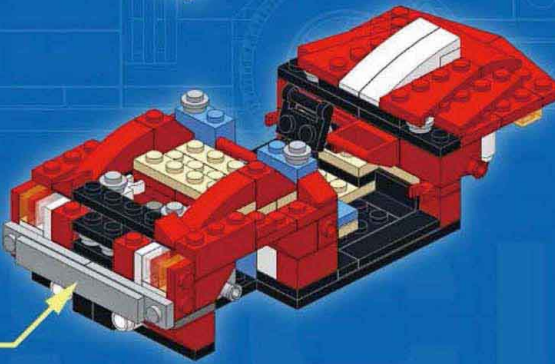
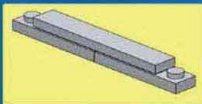
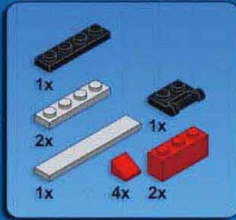



16

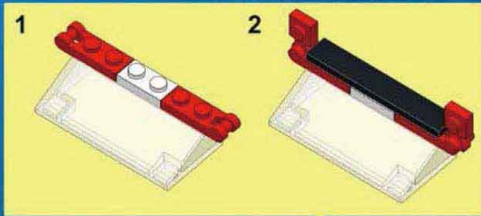
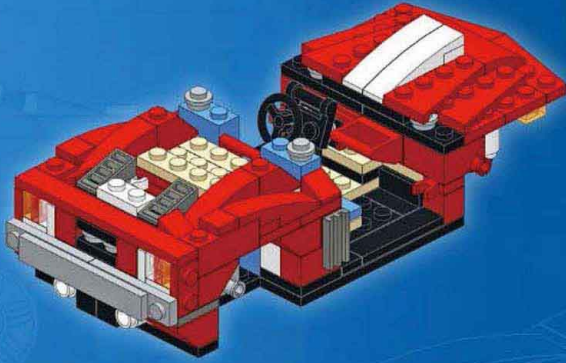
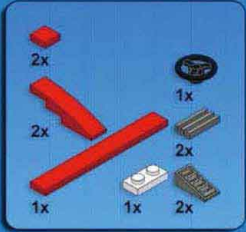

17

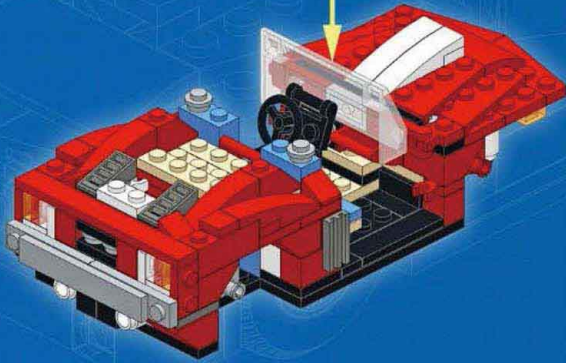
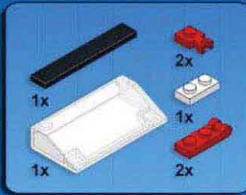

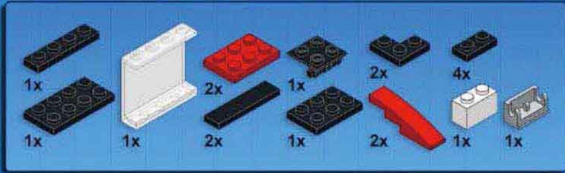

18

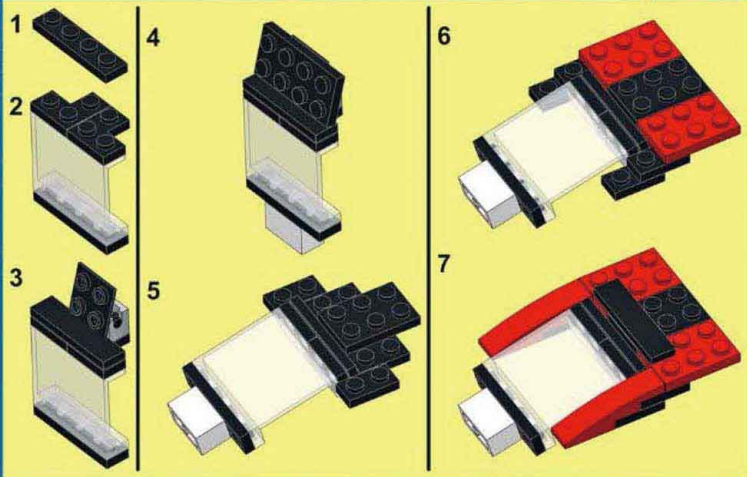
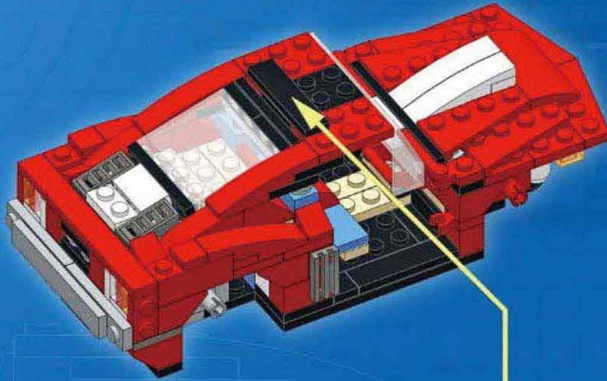



19

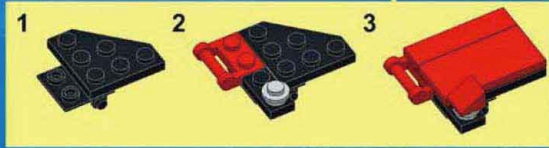
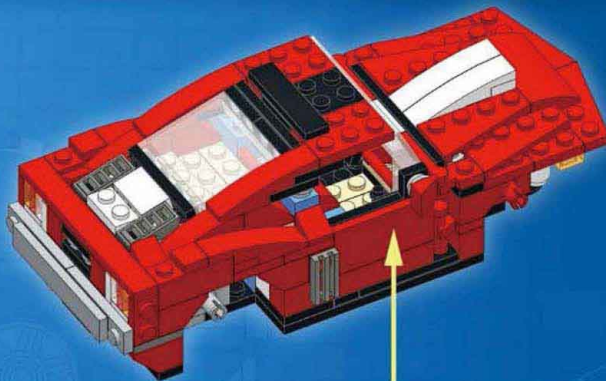
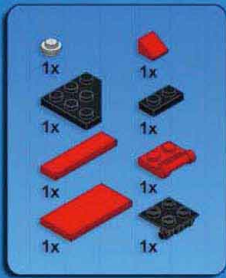

20

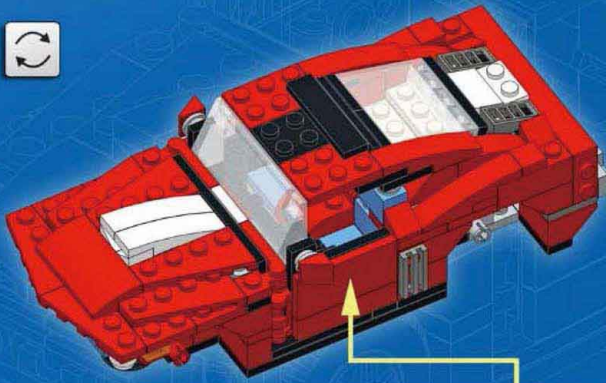
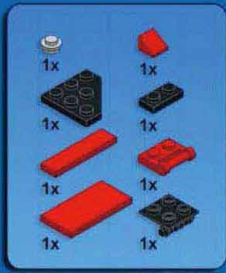



Complexity 
Functions 
Pieces 

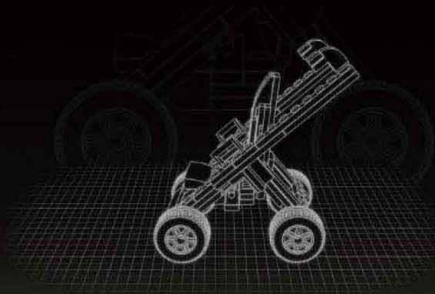

STROLLER

Design notes: open frame, upright chair, curved handlebars

Technical specifications:
Dimensions (l × w × h): 14 × 10 × 15 studs
Wheelbase: 8 studs
Axle width front/rear: 10/10 studs



1



1

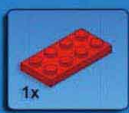

2

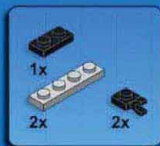

3

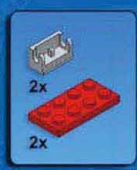

4

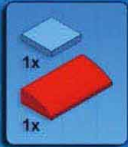
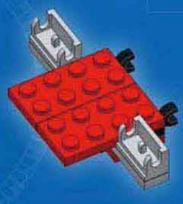

5

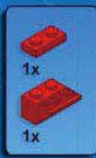
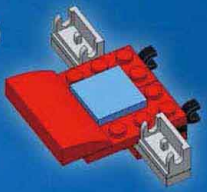

6

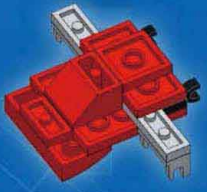

7

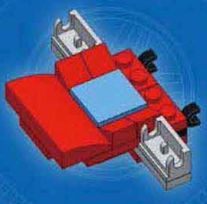

2

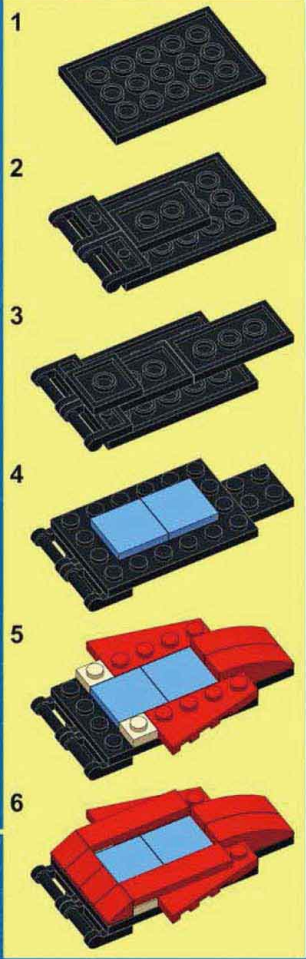
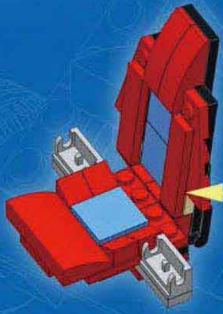
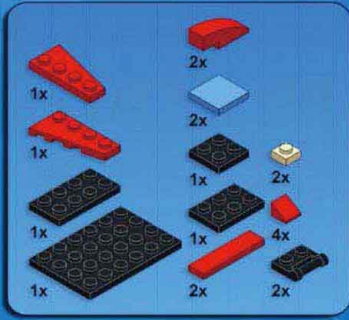



3

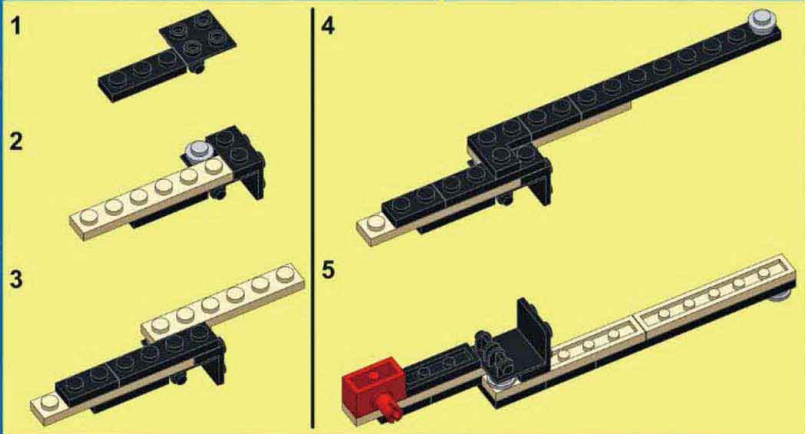
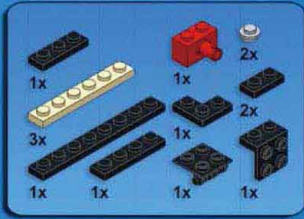

4

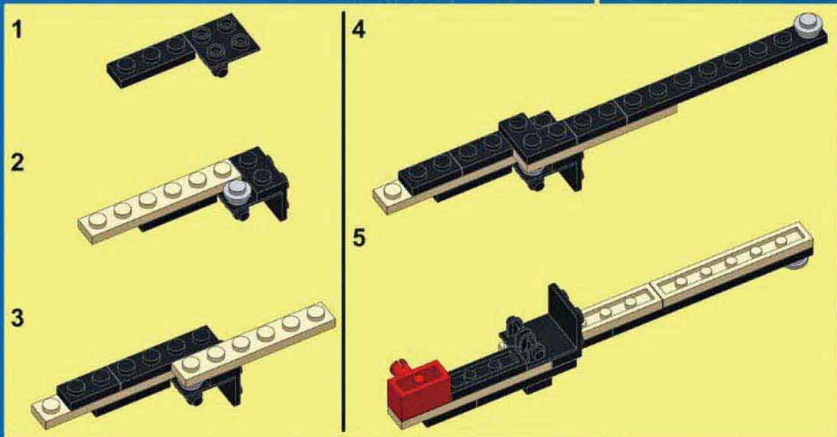
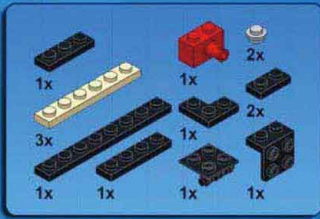



5

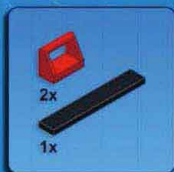

6

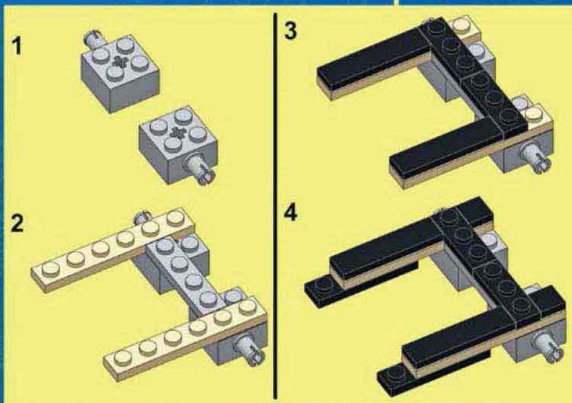
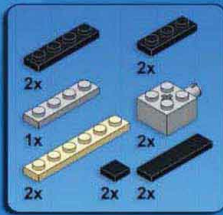



7

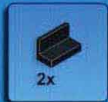

8

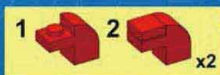



Complexity 
Functions 
Pieces 

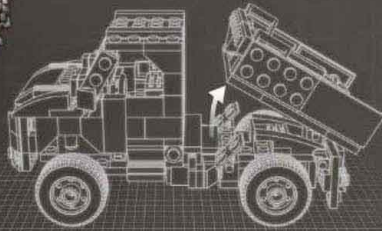
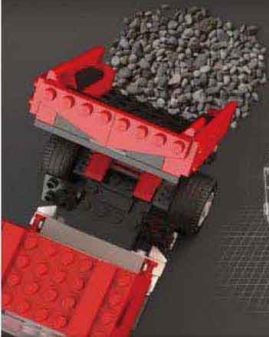

MULTI-PURPOSE TRUCK

Design notes: short nose, wide axle, high clearance

Technical specifications:

Dimensions (l x w x h): 19 x 11 x 11 studs

Wheelbase: 11 studs

Axle width front/rear: 10/10 studs

Features: tipping bed



1

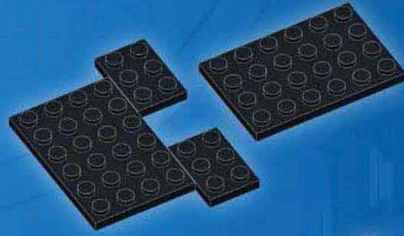

2

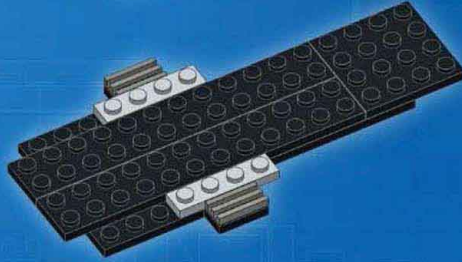
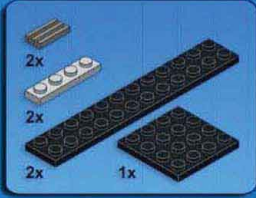

3



4

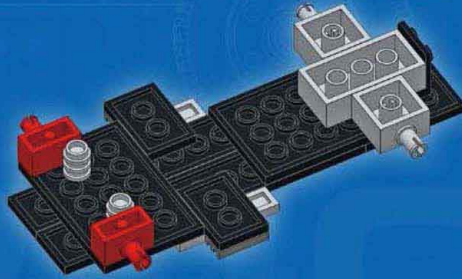
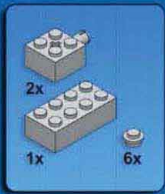

5

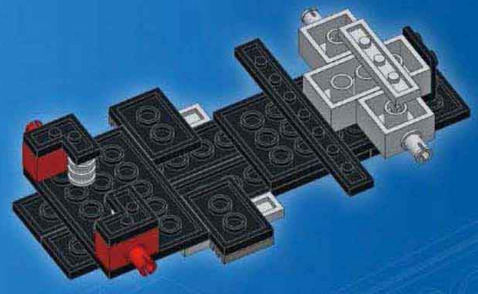
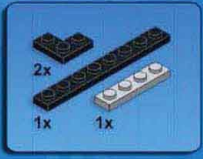

6

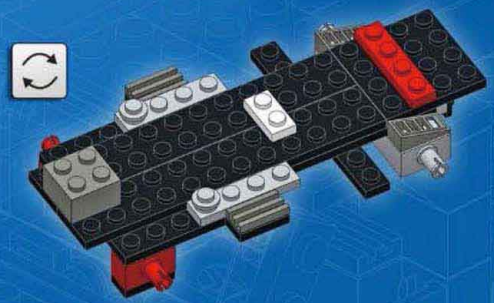
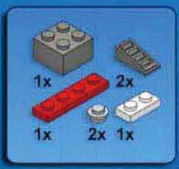

7

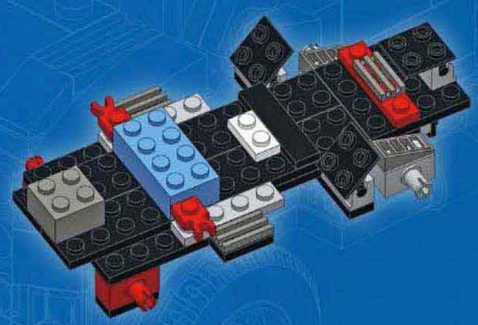
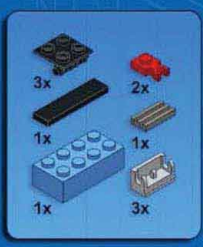



8

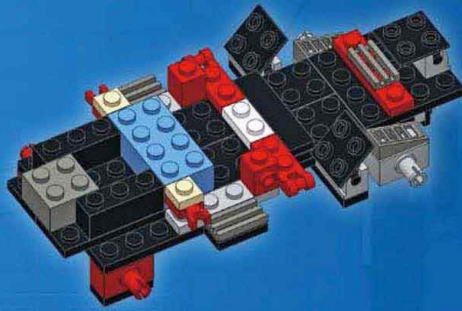
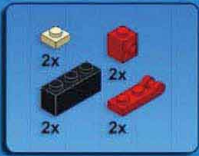

9

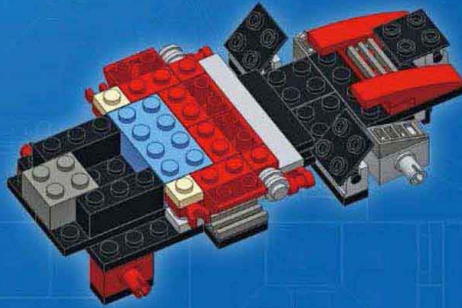
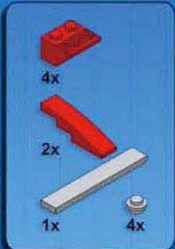

10

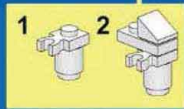

11

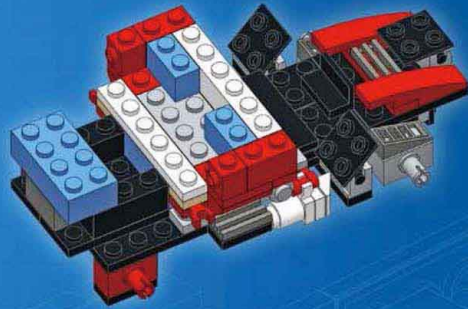
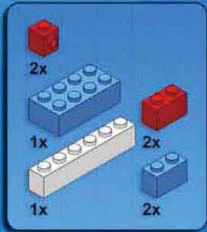

12

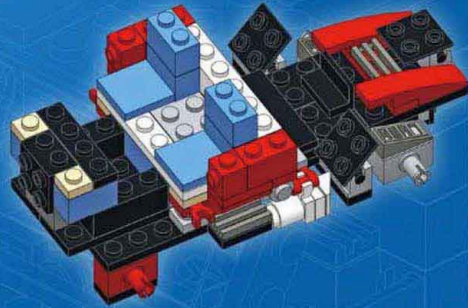

13

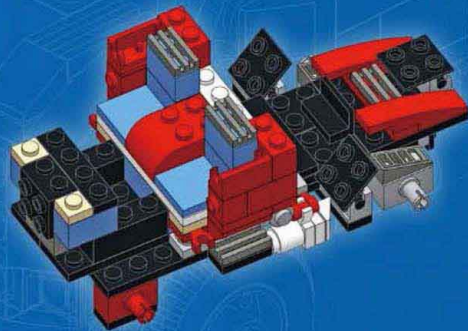
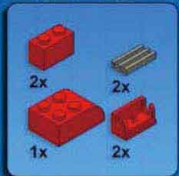



14

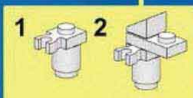
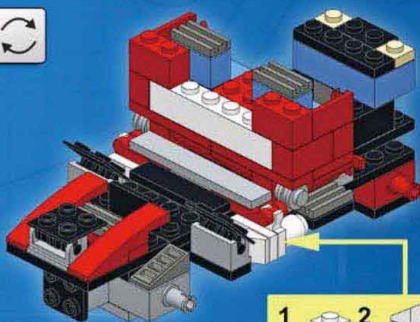

15

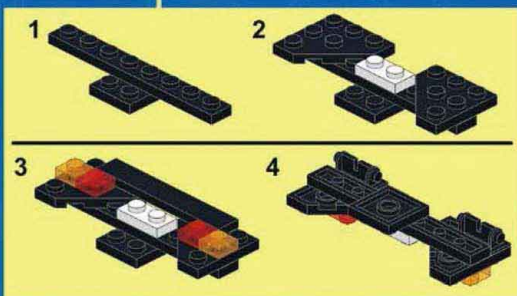
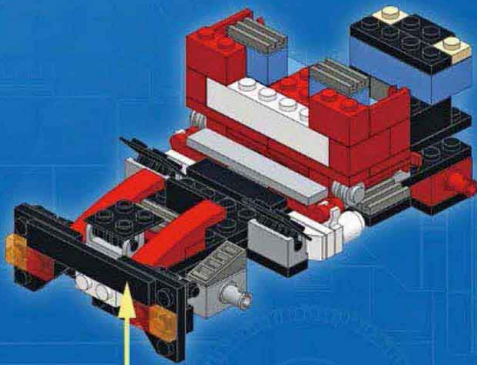
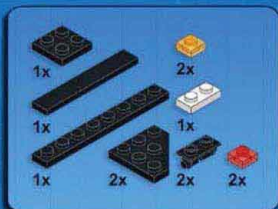

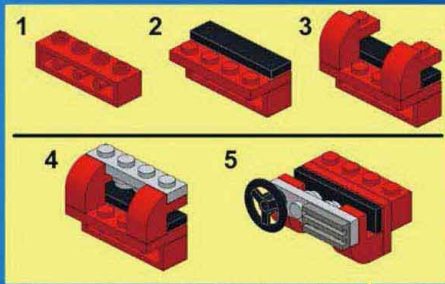

16

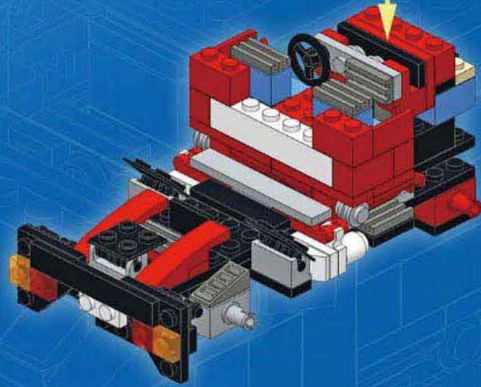
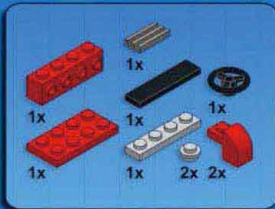



17

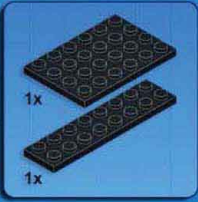

1

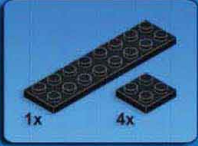

2

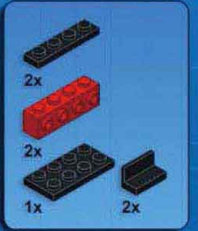

3

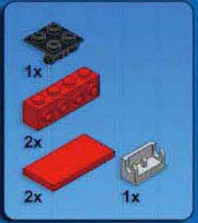
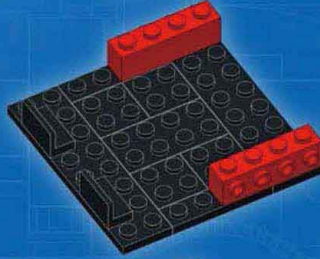

4

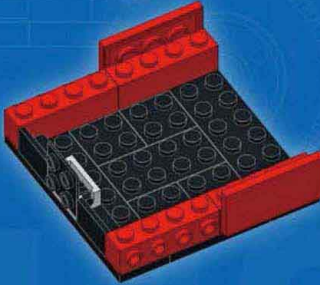

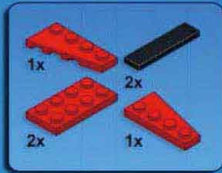

5

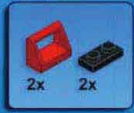
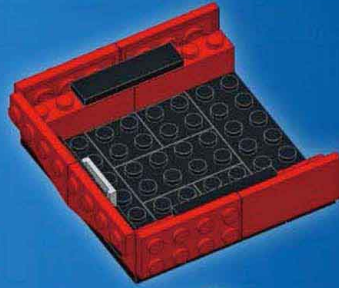

6

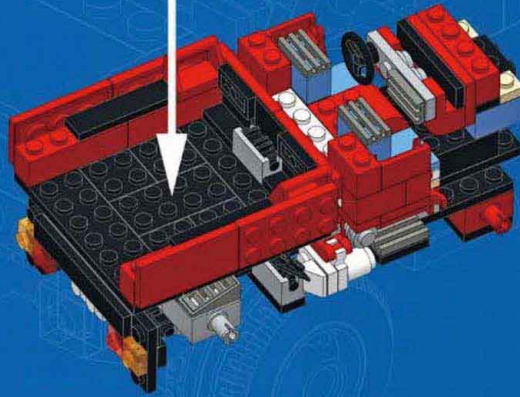



18

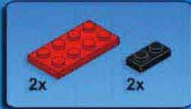

1

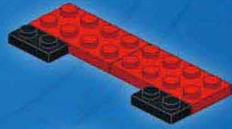

2



3

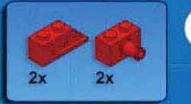

4

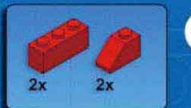
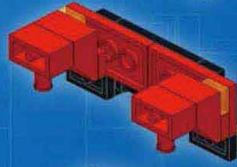

5

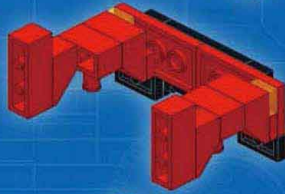

6

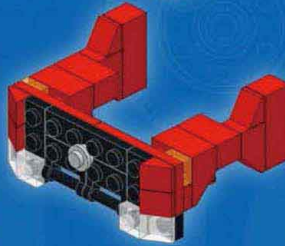

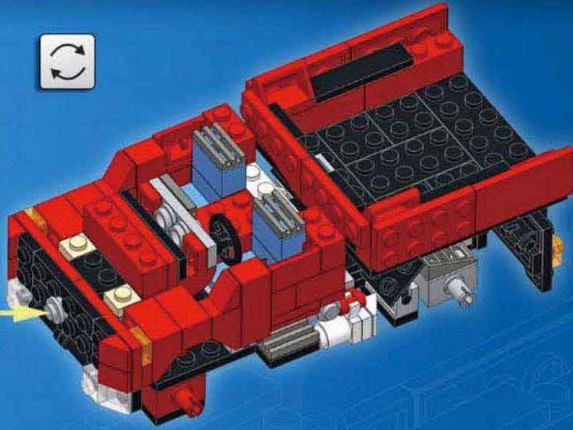
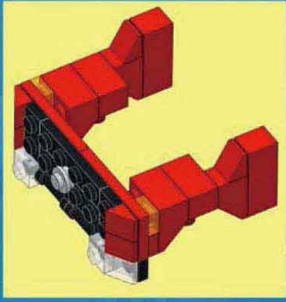

19

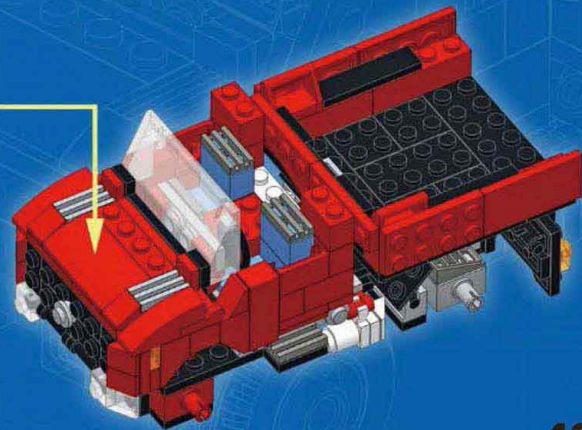
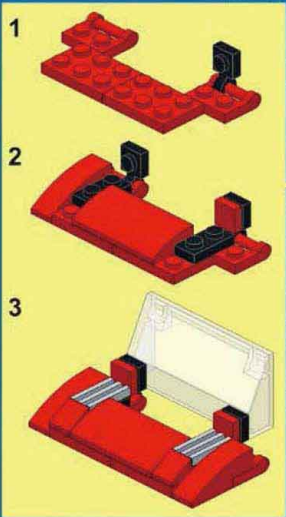
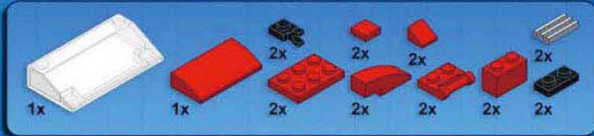



20

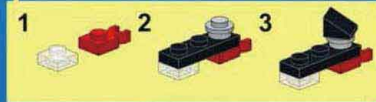
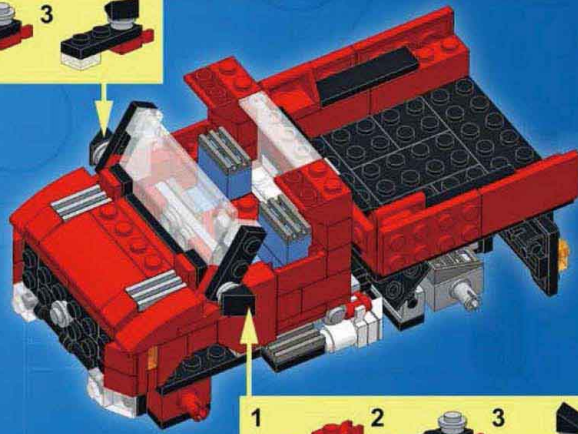
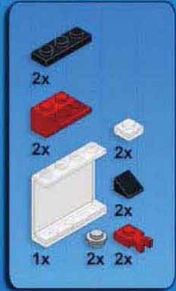

21

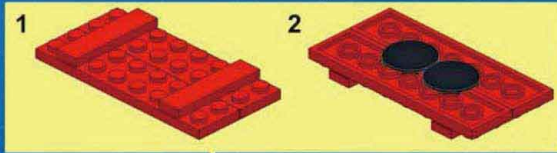
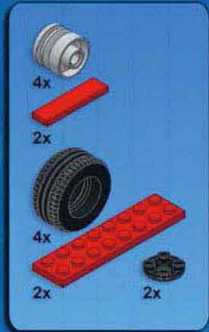



Complexity 
Functions 
Pieces 



HISTORIC RACER

Design notes: bullet shape, minimal aeroscreen, wide wheelbase, six-cylinder engine, rollbar

Technical specifications:
Dimensions (l x w x h): 19 x 10 x 6 studs
Wheelbase: 12 studs
Axle width front/rear: 10/10 studs

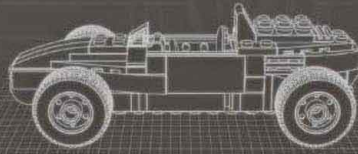

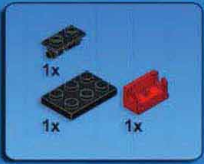

1

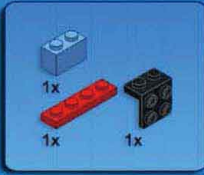

2

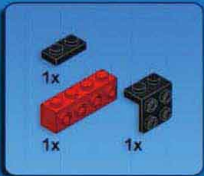

3

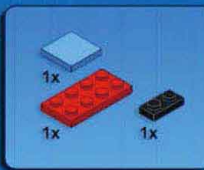

4

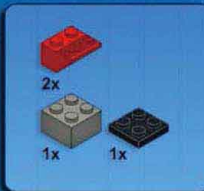
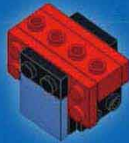

5



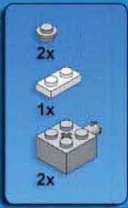
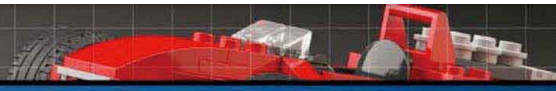

6

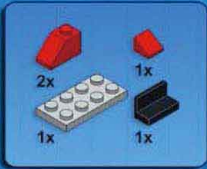
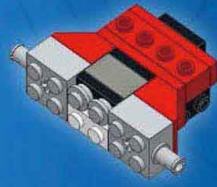

7

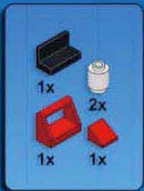
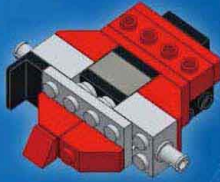

8

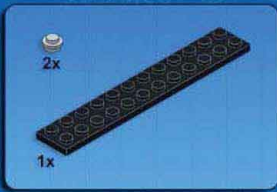

9





10

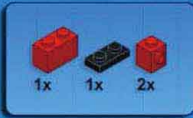

1

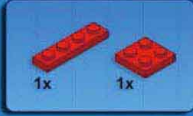

2

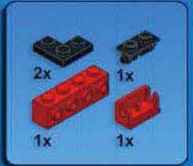

3

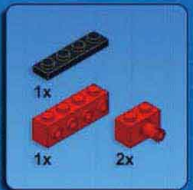
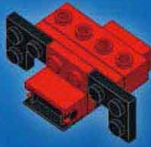

4

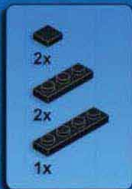
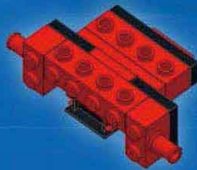

5

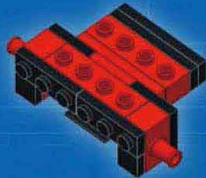

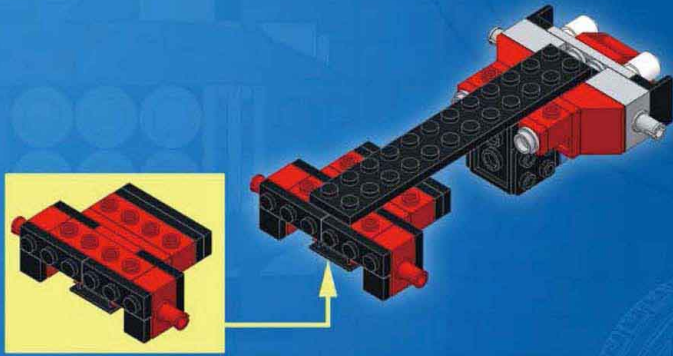

11

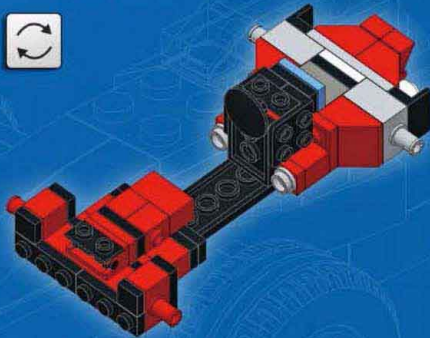



12

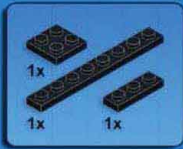

1

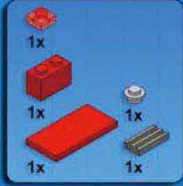

2

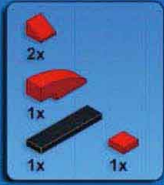
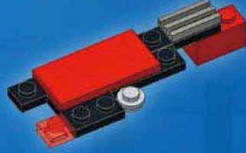

3

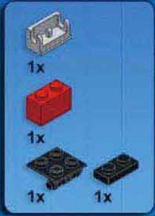

4

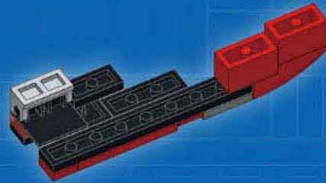

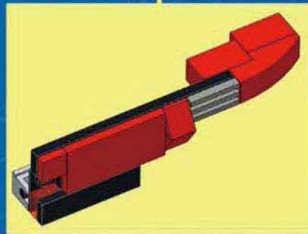
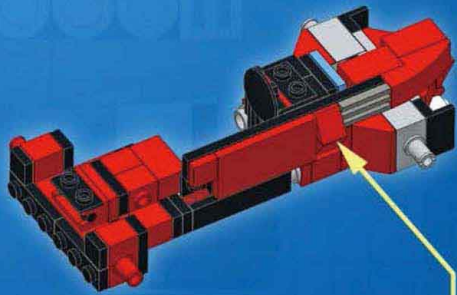



13

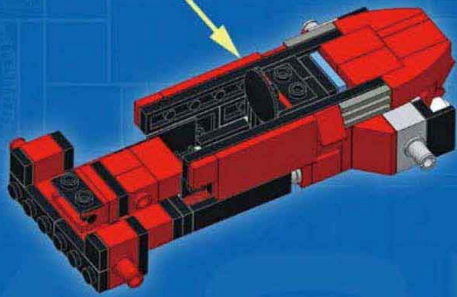
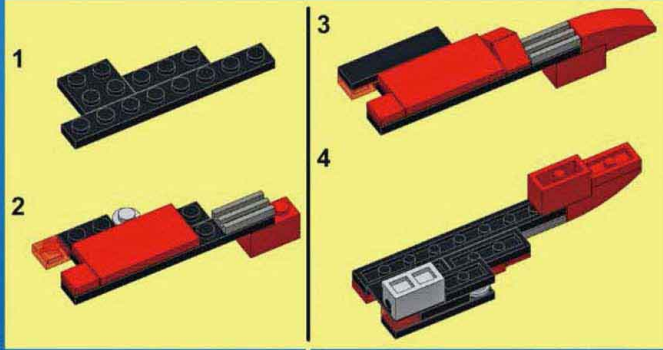
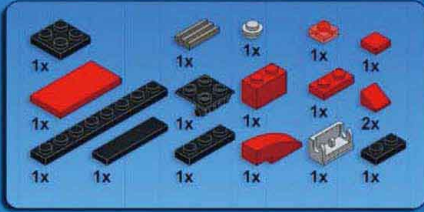

14

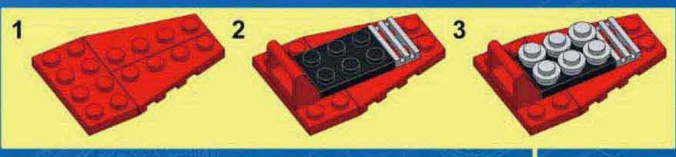
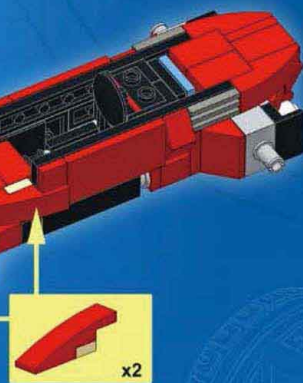
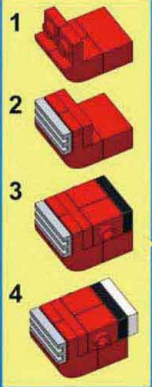
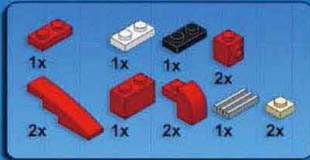

15

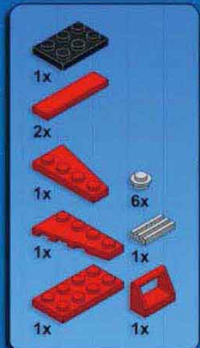

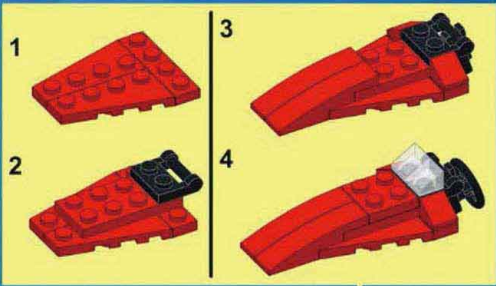

16

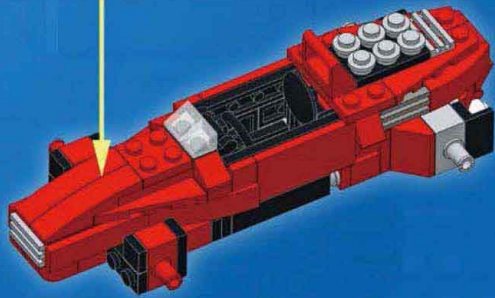
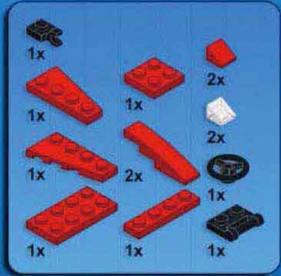

17





Complexity 
Functions 
Pieces 

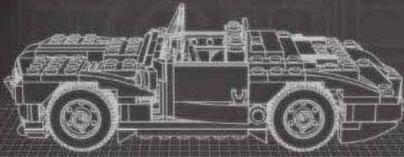
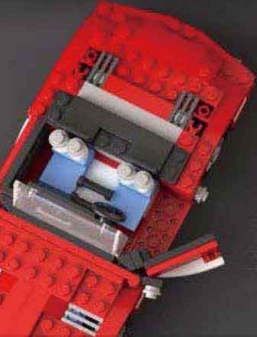
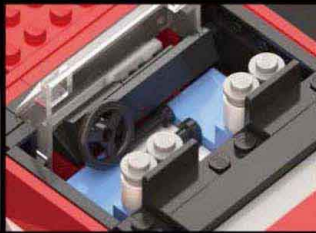
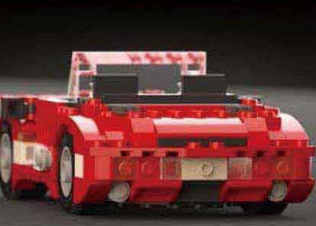

CLASSIC CAR

Design notes: wide chassis, convertible, wide stripe, classic curves

Technical specifications:
Dimensions (l x w x h): 23 x 13 x 7 studs
Wheelbase: 12 studs
Axle width front/rear: 10/10 studs

Features: opening doors

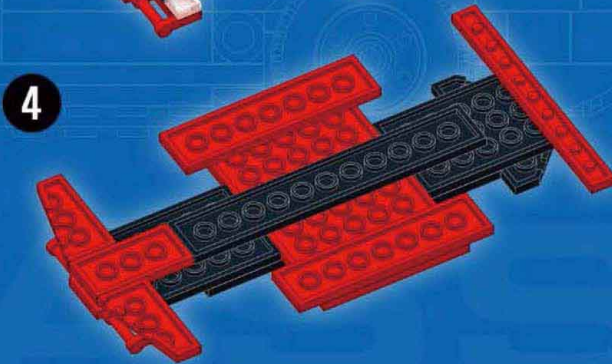
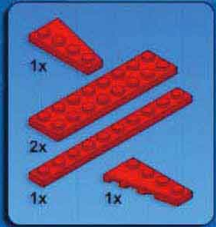
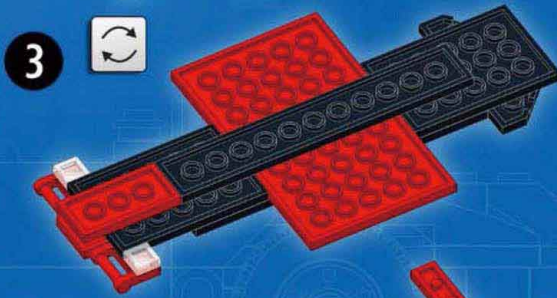
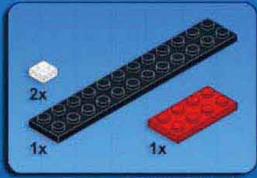
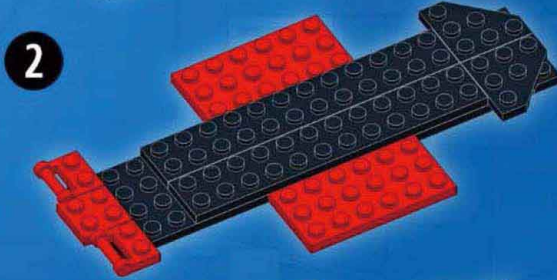
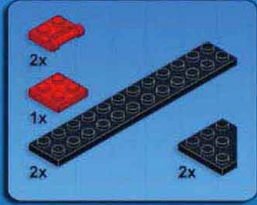
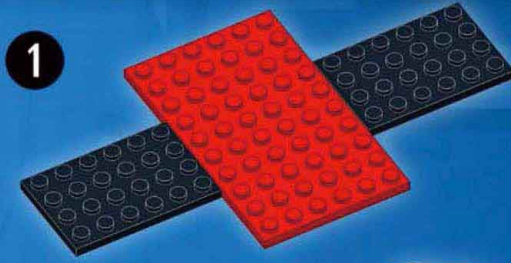
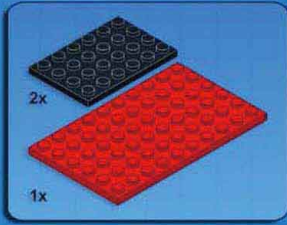

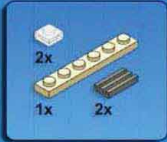

5

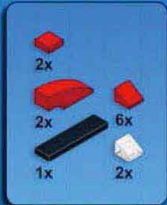
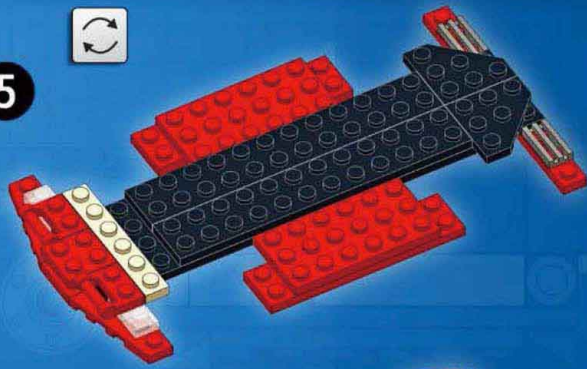

6

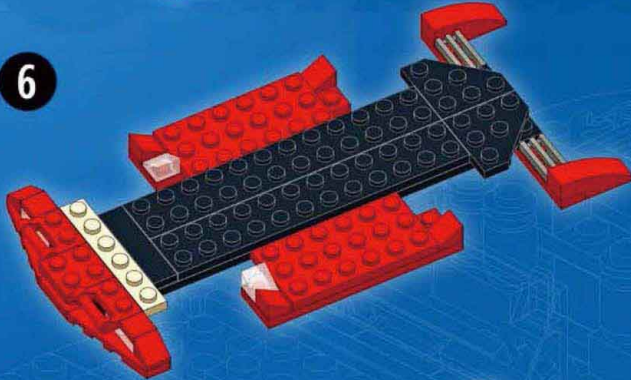

7

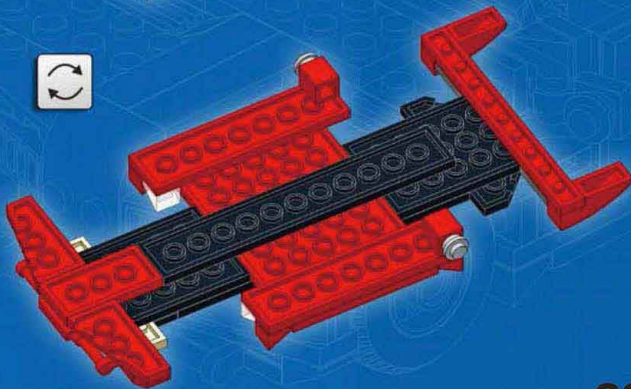



8

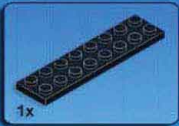

1



2

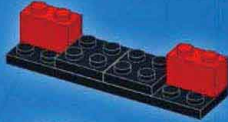

3

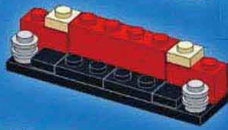

4



5



6

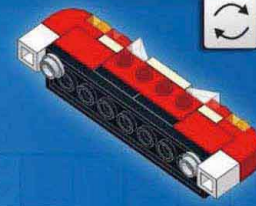

7

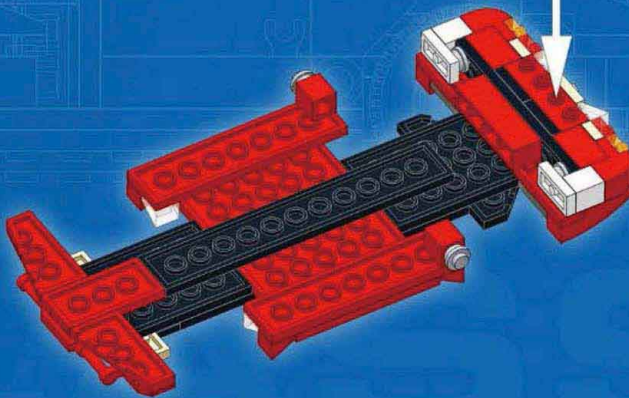
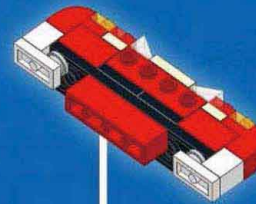
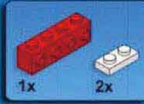

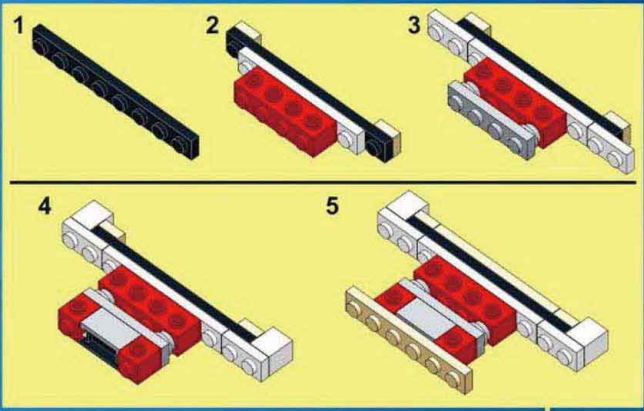

- 1x [Grey Technic Axle Pin]
- 1x [Red 1x4 Technic Brick]
- 1x [White 1x4 Technic Axle]
- 1x [Yellow 1x4 Technic Axle]
- 2x [Black 1x10 Technic Axle]
- 1x [White 1x4 Technic Axle]
- 1x [Black 1x1 Technic Axle Pin]
- 2x [Yellow 1x2 Technic Axle Pin]
- 2x [Yellow 1x2 Technic Axle Pin]
- 2x [White 1x2 Technic Axle Pin]
- 2x [Red 1x1 Technic Axle Pin]
- 2x [White 1x2 Technic Axle Pin]
- 2x [Black 1x1 Technic Axle Pin]

9

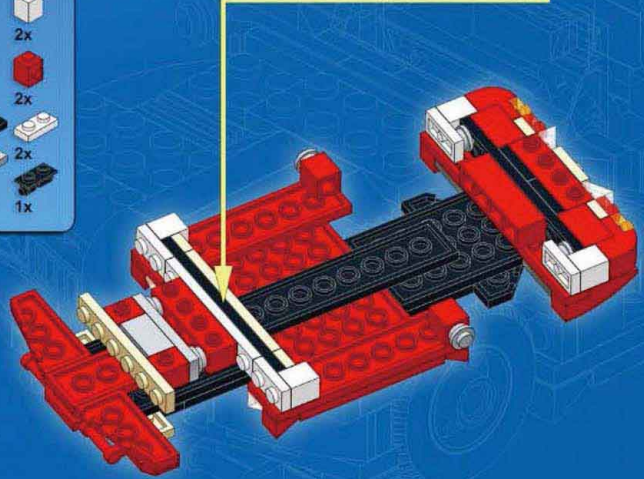



12

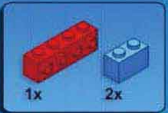

1

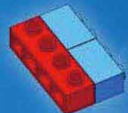

2

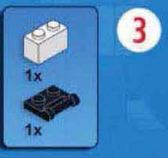
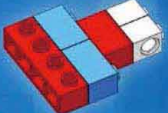

3

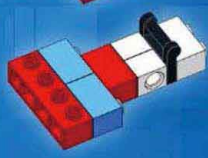

4

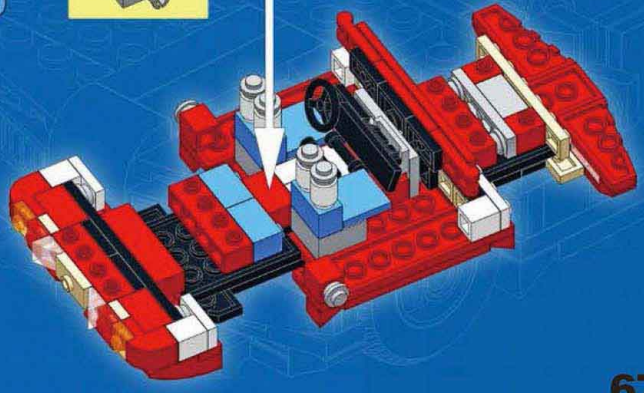
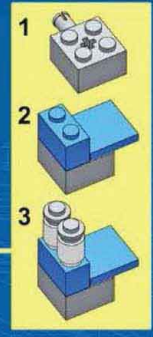
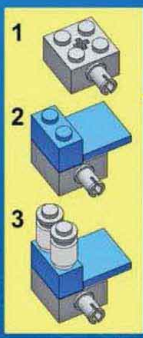



13

- 1x [Black 1x3 Technic Brick with 2 Holes]
- 1x [Red 1x3 Technic Brick with 2 Holes]
- 1x [Black 1x2 Technic Brick with 2 Holes]
- 1x [Red 1x2 Technic Brick with 2 Holes]
- 1x [White 1x3 Technic Brick with 2 Holes]
- 1x [Red 1x2 Technic Brick with 2 Holes]
- 1x [Black 1x3 Technic Brick with 2 Holes]
- 1x [Red 1x3 Technic Brick with 2 Holes]
- 1x [Black 1x3 Technic Brick with 2 Holes]
- 1x [Red 1x3 Technic Brick with 2 Holes]

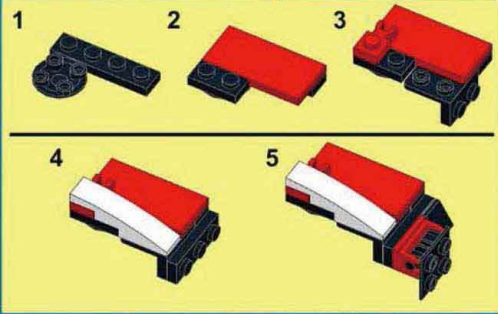
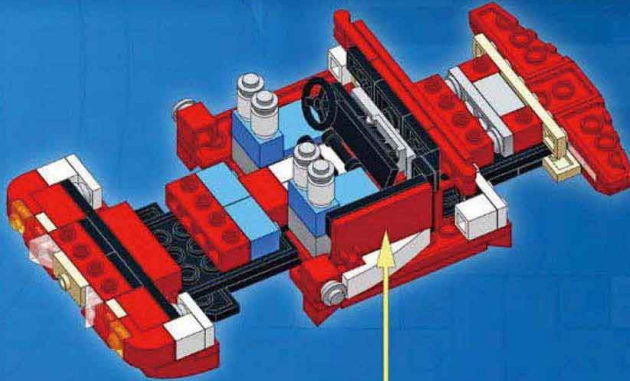

14

- 1x [White 1x3 Technic Brick with 2 Holes]

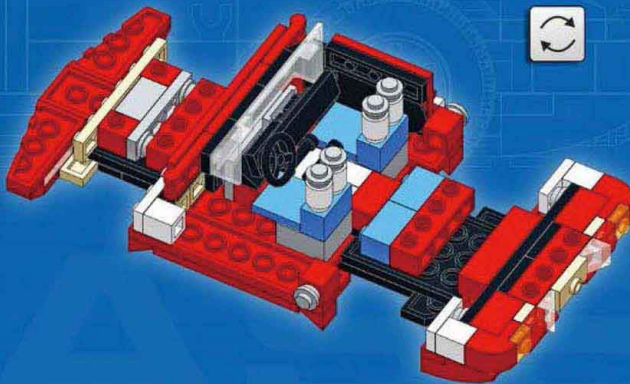



15

- 1x [Black 1x3 Technic Brick]
- 1x [Red 1x2 Technic Brick]
- 1x [Black 1x2 Technic Brick]
- 1x [Black 1x2 Technic Brick]
- 1x [White 1x2 Technic Brick]
- 1x [Red 1x2 Technic Brick]
- 1x [Black 1x3 Technic Brick]
- 1x [Red 1x2 Technic Brick]
- 1x [Red 1x2 Technic Brick]
- 1x [Black 1x2 Technic Brick]

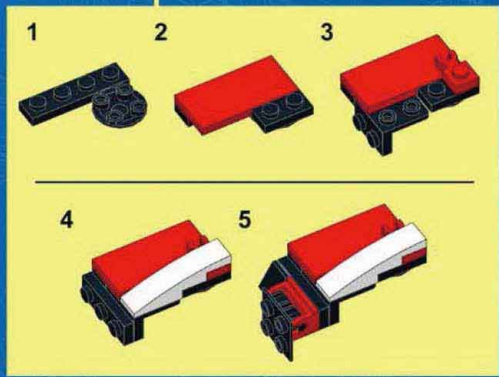
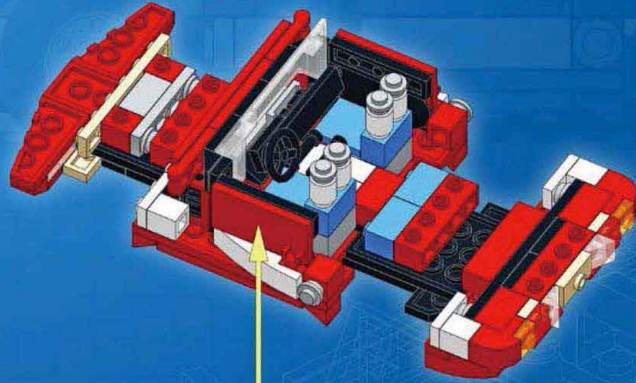



16

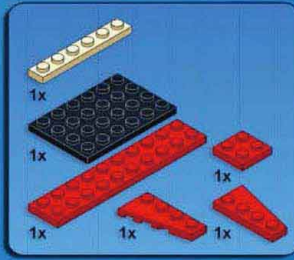

1

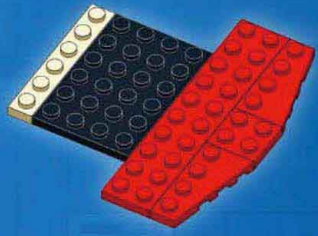

2

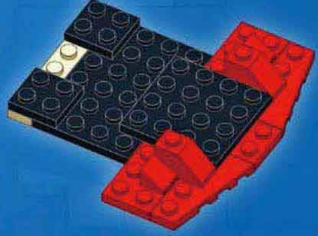
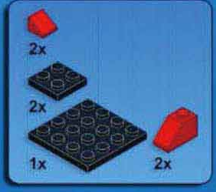

3

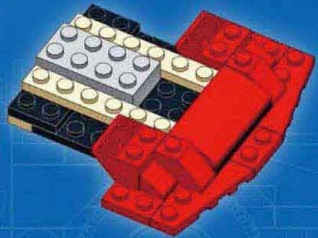
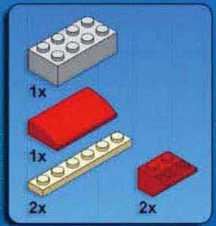

4

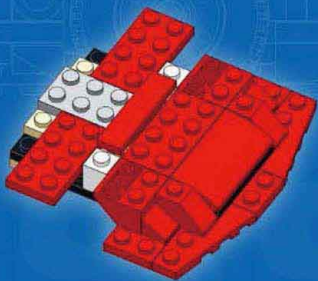
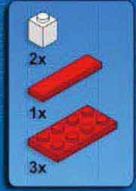

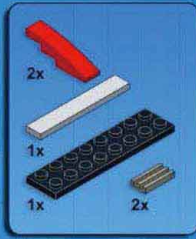

5

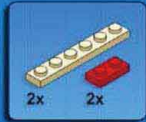
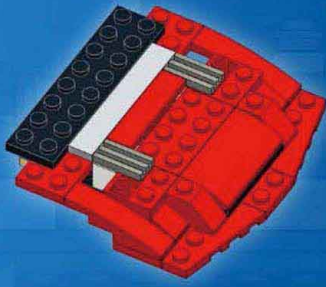

6

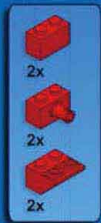
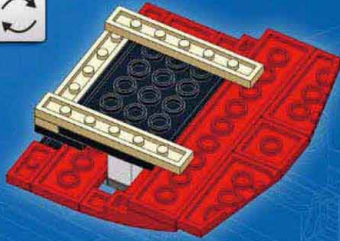

7

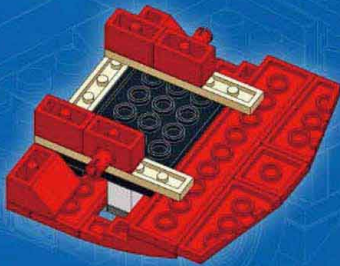



8

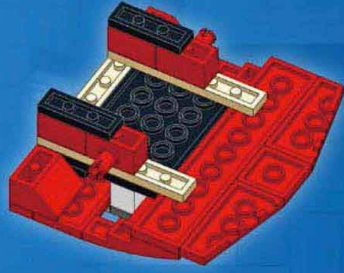

9

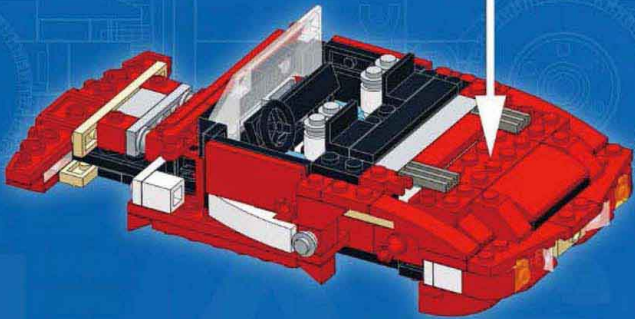
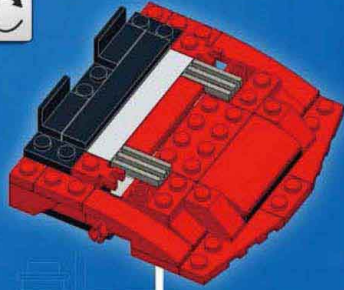

17

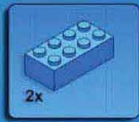

1

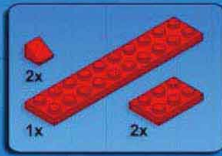
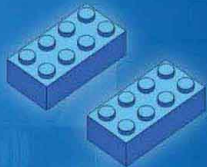

2

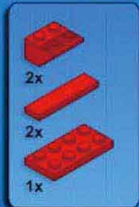
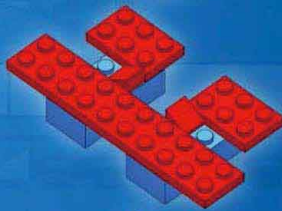

3

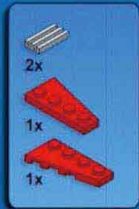
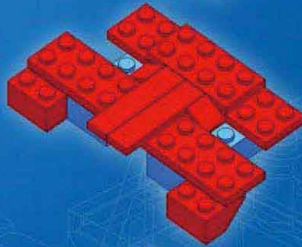

4

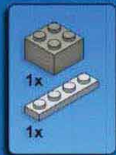
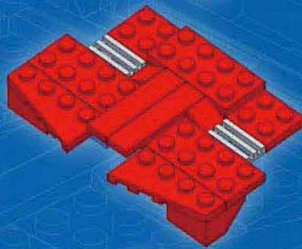

5

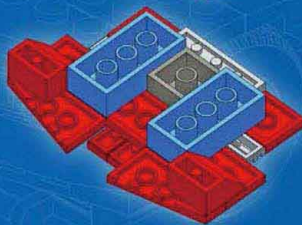

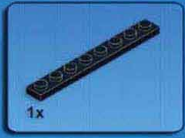

6

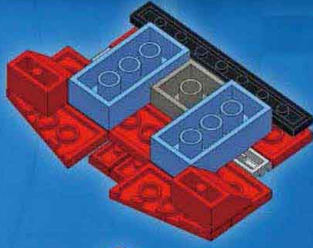

7

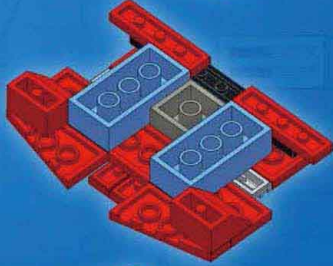

8

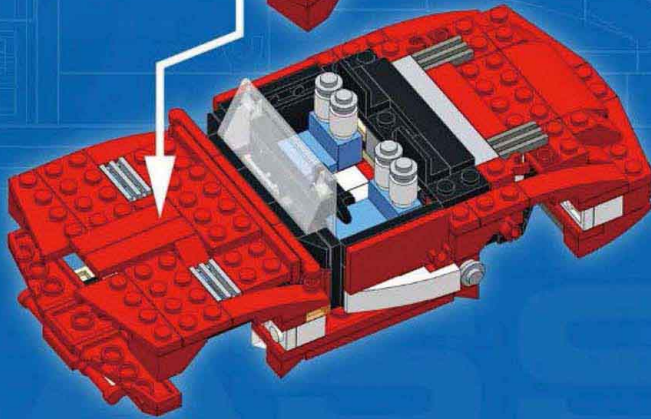
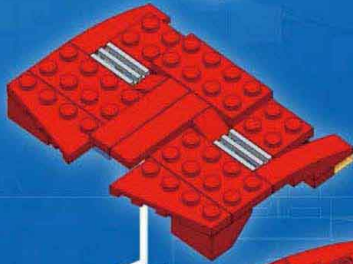

18

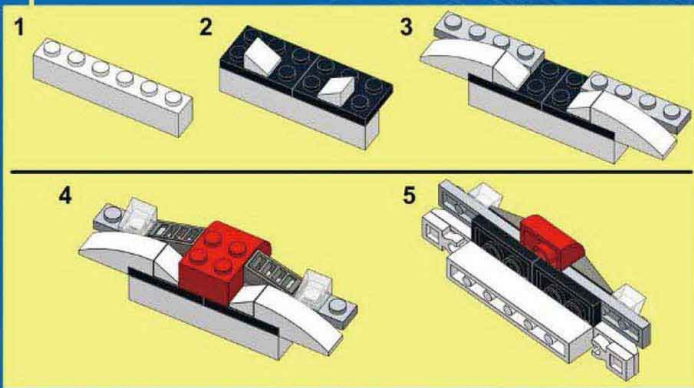
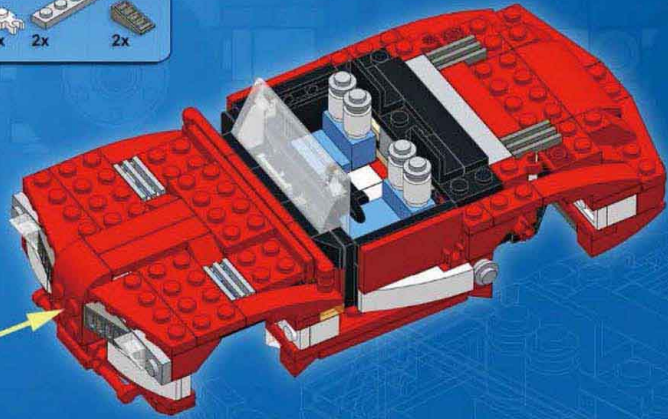
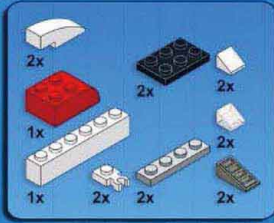



19

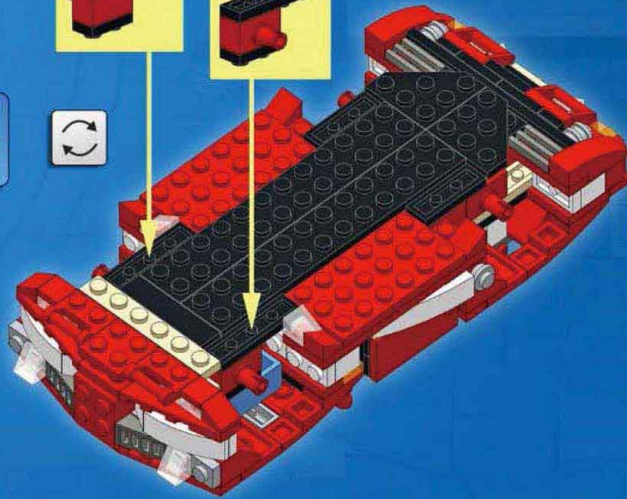
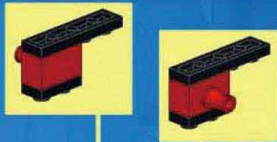
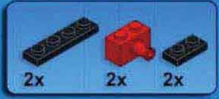

20

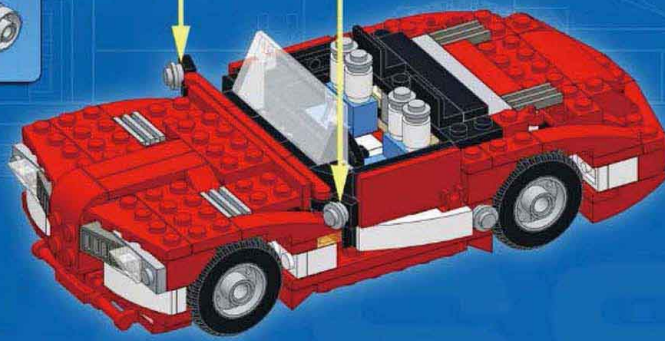



Complexity 
Functions 
Pieces 

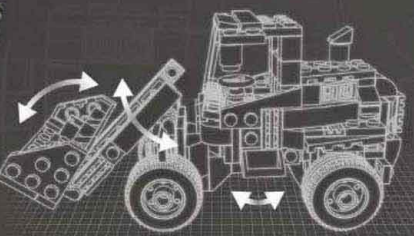

WHEEL LOADER

Design notes: heavy-duty construction, central cabin

Technical specifications:
Dimensions (l x w x h): 21 x 10 x 11 studs
Wheelbase: 9 studs
Axle width front/rear: 8/8 studs

Features: articulated steering, arm elevation, tipping bucket



1

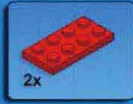

1

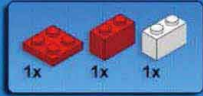
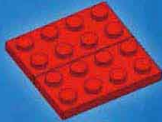

2

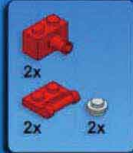
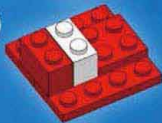

3

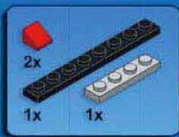
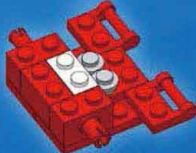

4

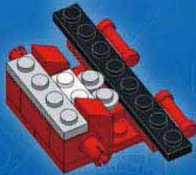

5

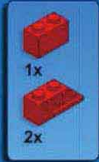
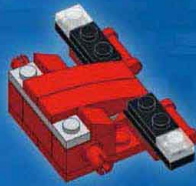

6

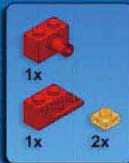
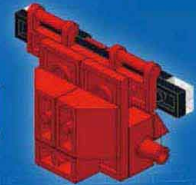

7

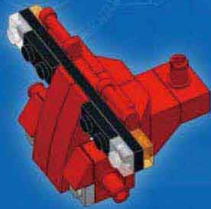
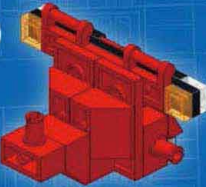



2

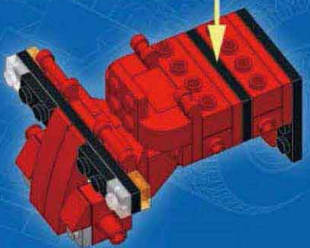
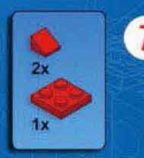
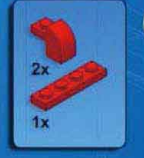
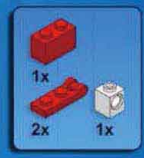
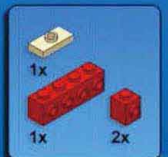
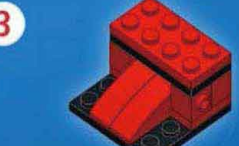
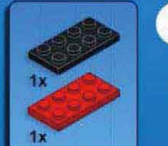
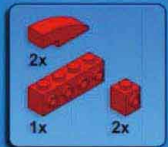
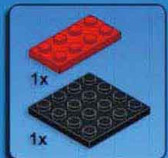

4

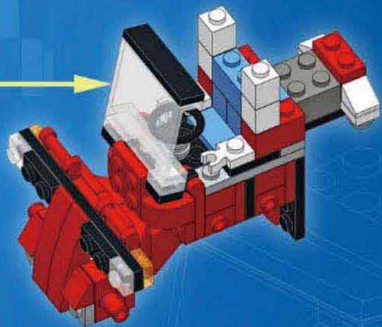
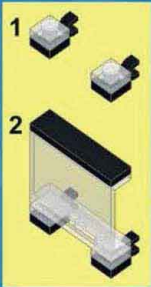

5

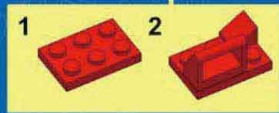
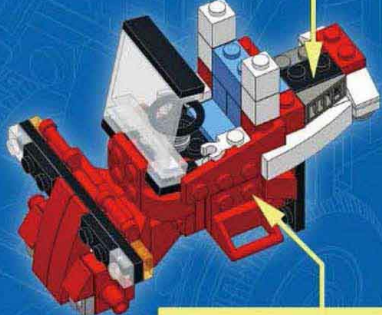
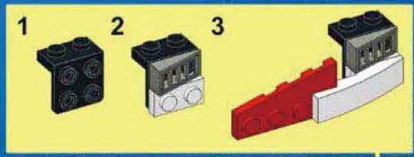
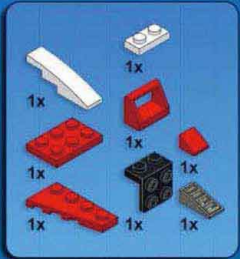

8

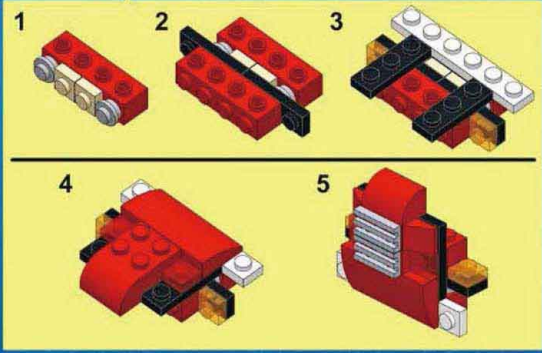
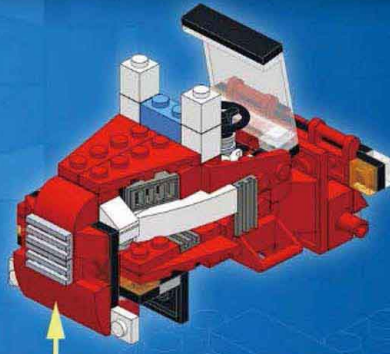
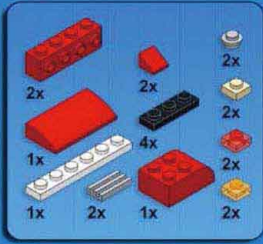

9

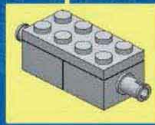
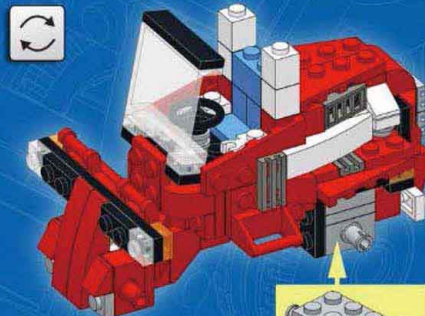
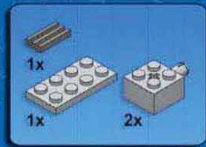



10

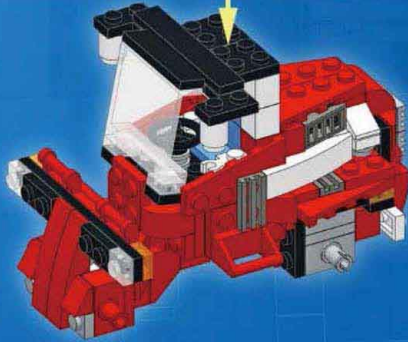
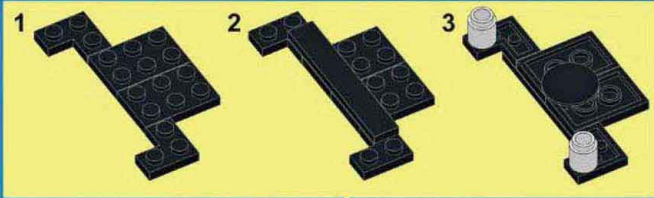
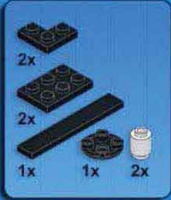

1



2

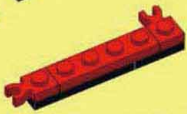

3

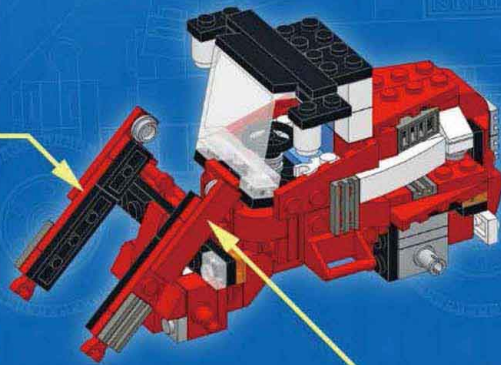
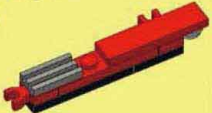

11

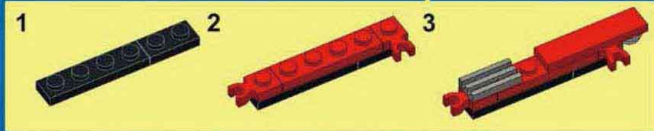
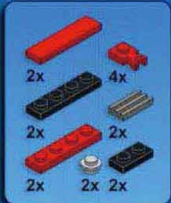

12

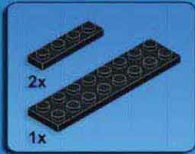

1

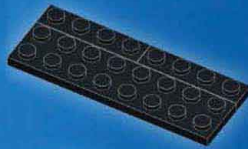

2

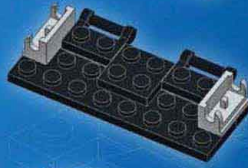

3

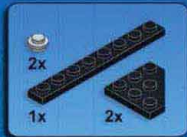
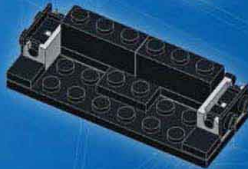

4

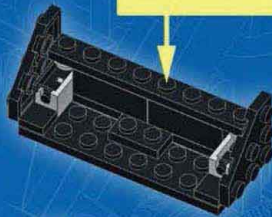
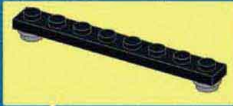

5

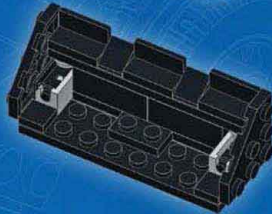

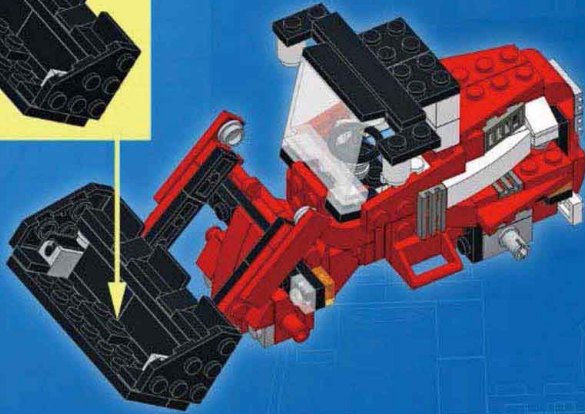
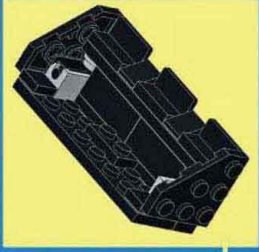

13



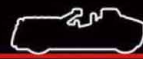

Complexity 
Functions 
Pieces 

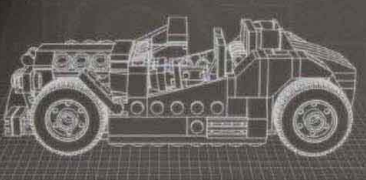
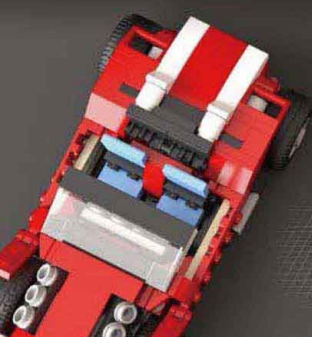

STREET ROD

Design notes: wide rear axle, lowrider, exposed V6 engine, detailed two-seat interior

Technical specifications:
Dimensions (l x w x h): 19 x 10 x 6 studs
Wheelbase: 12 studs
Axle width front/rear: 9/10 studs

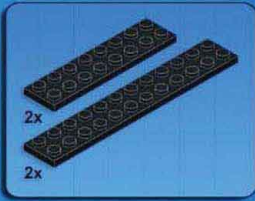

1

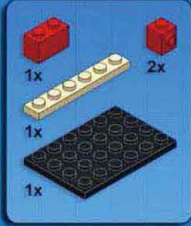

2

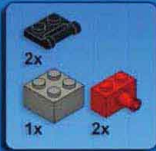

3

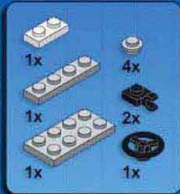
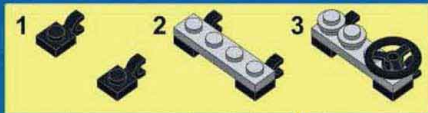
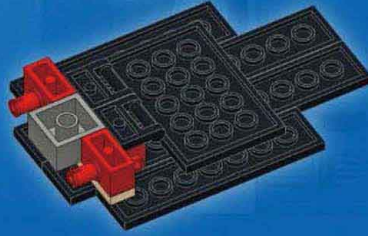

4



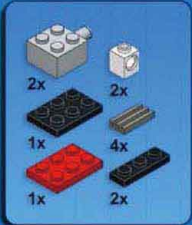
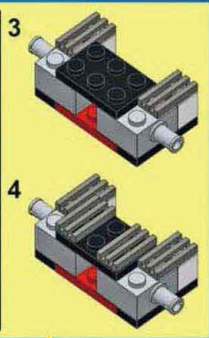
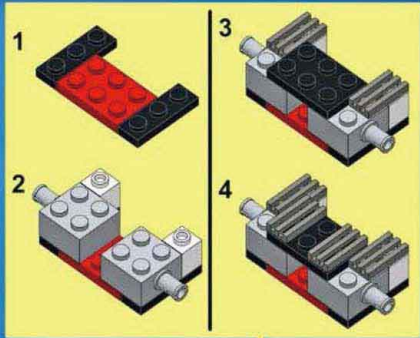

5

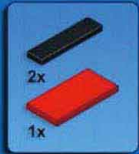
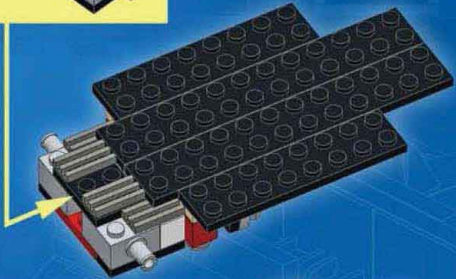

6

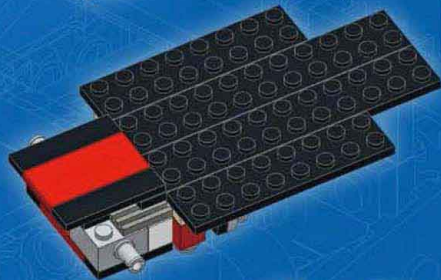

7

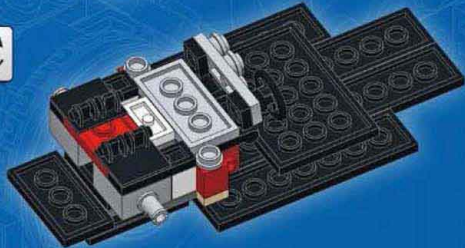

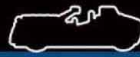

8

- 2x
- 1x
- 3x
- 1x
- 2x
- 1x

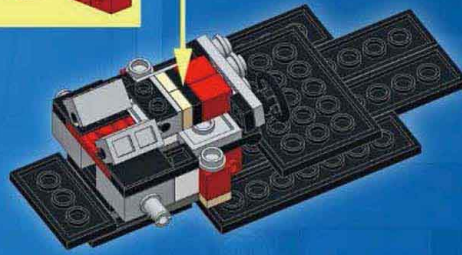
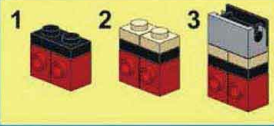

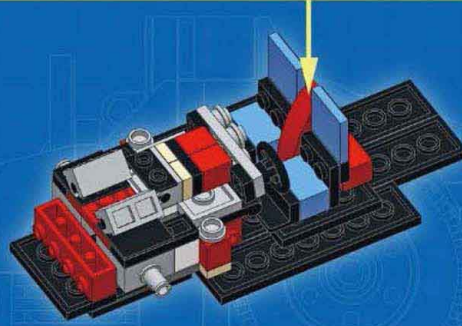
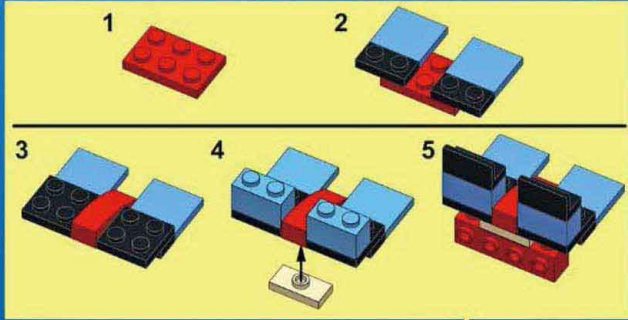

9

- 1x
- 2x
- 2x
- 2x
- 1x
- 1x
- 1x
- 2x
- 2x
- 2x



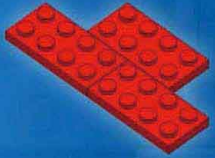

10  3x





1 

 1x
 1x

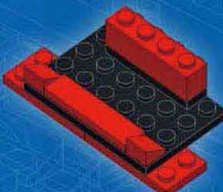
2 

 1x
 1x
 2x

3 

 2x
 1x
 2x
 2x

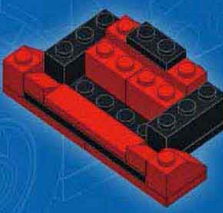
4 

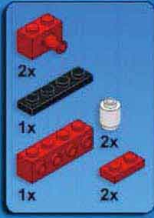
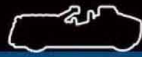

5

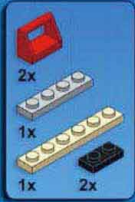
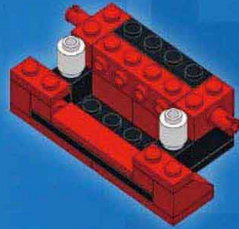

6

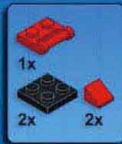
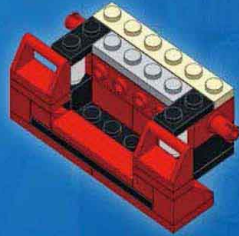

7

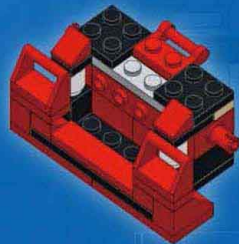

8

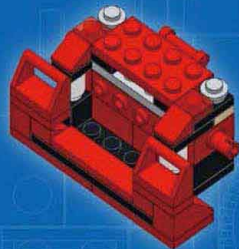



9

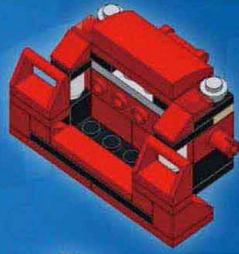

10

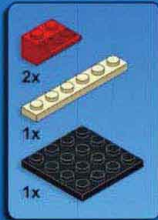
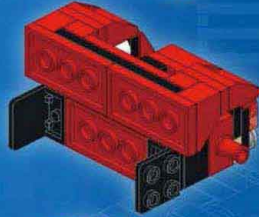

11

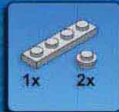
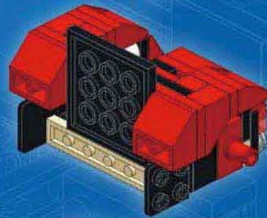

12

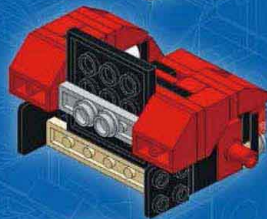

13

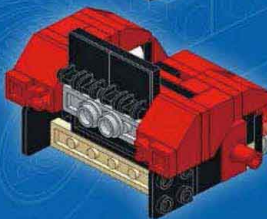

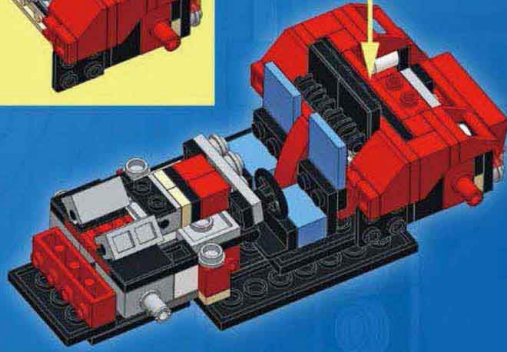
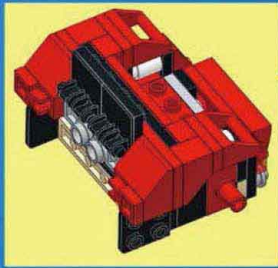

11

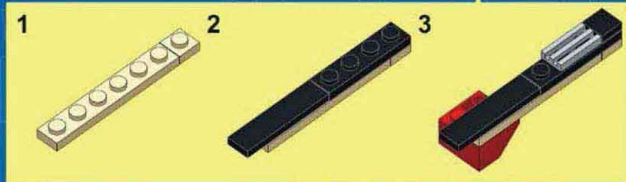
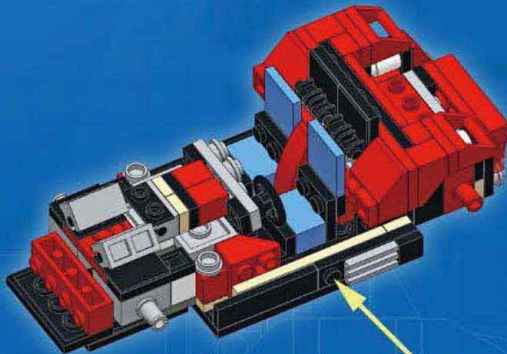
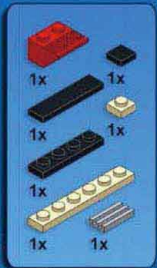



15

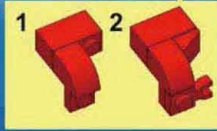
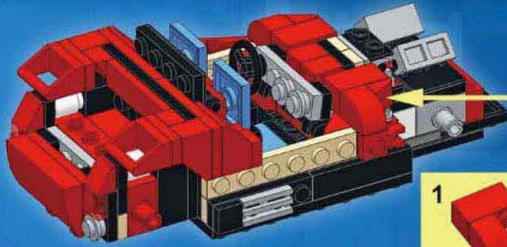
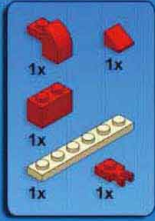

16

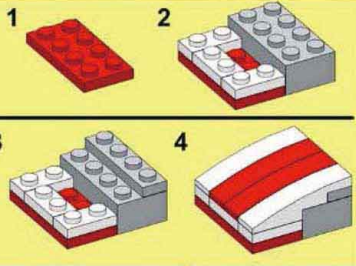
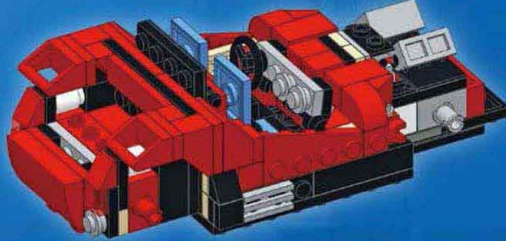

17

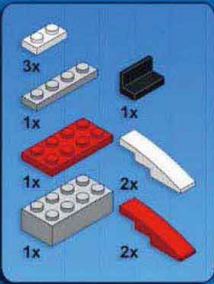

18

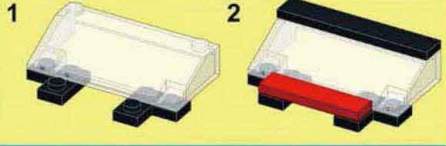
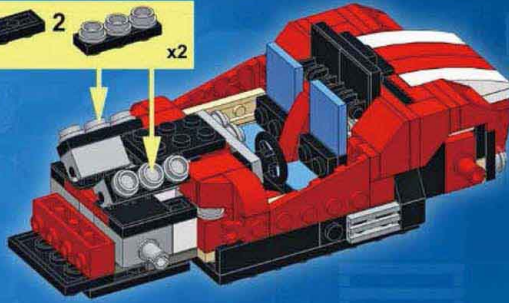

19

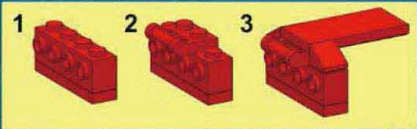
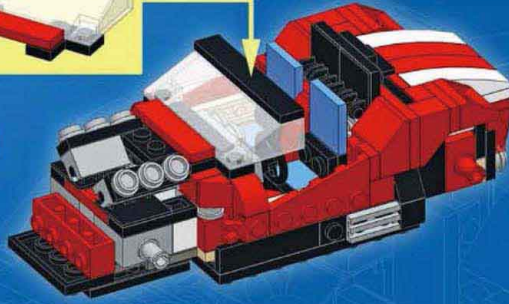
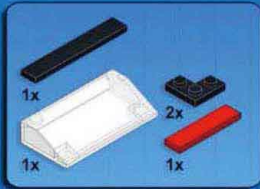

20

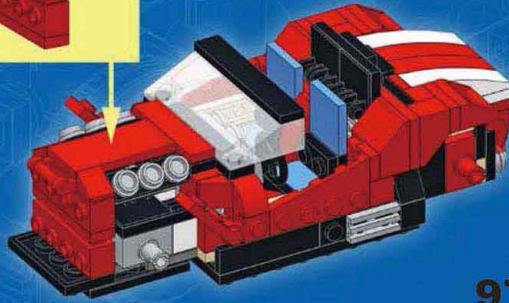
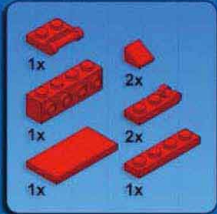

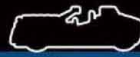

21

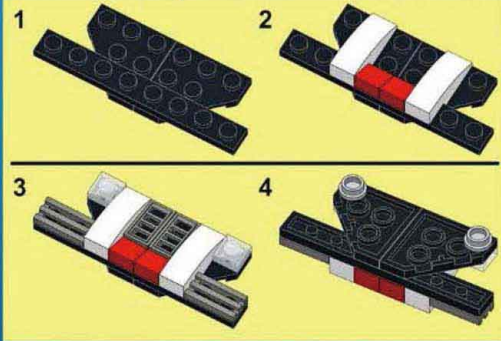
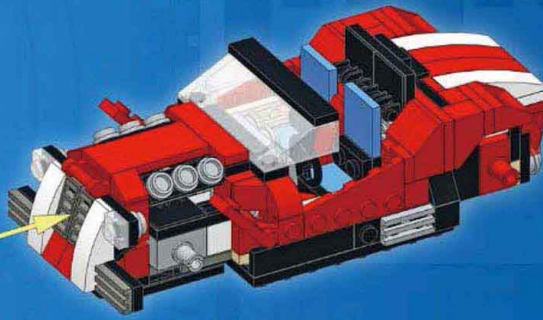
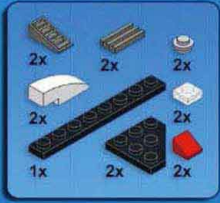

22

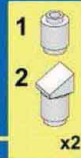
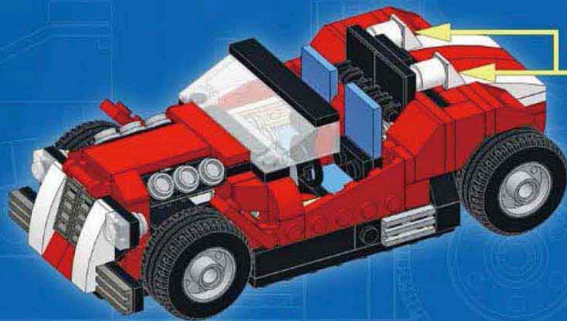



Complexity

Functions

Pieces

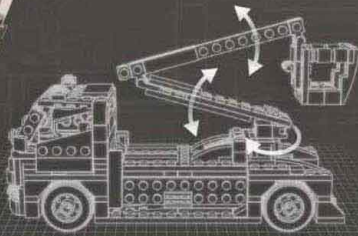
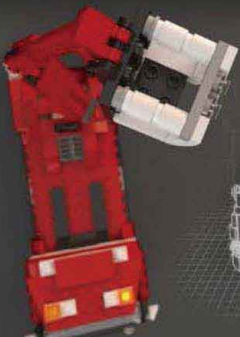
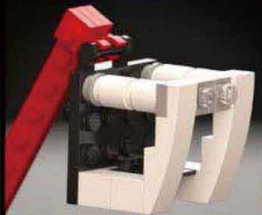

RESCUE TRUCK

Design notes: long wheelbase, cherry picker arm with bucket, massive front grille, hazard lights

Technical specifications:
Dimensions (l x w x h): 26 x 10 x 11 studs
Wheelbase: 16 studs
Axle width front/rear: 8/8 studs

Features: boom rotation, boom elevation

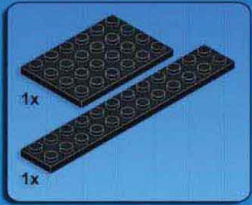
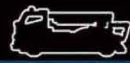

1

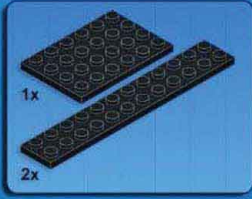
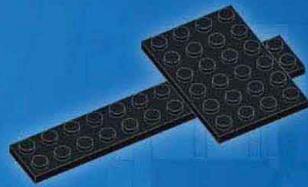

2

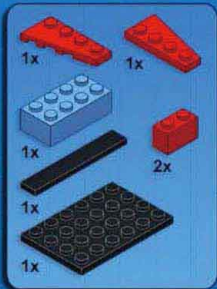

3

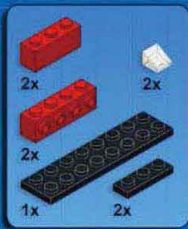
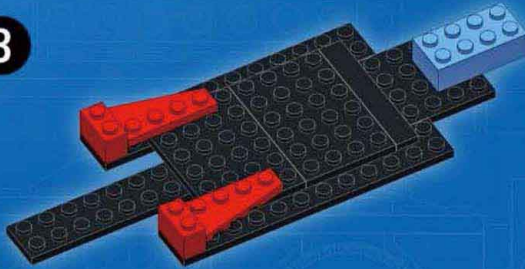

4

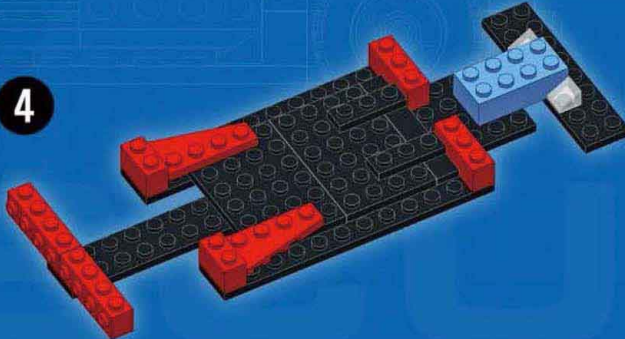



5

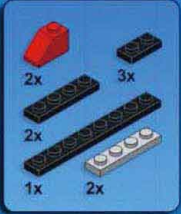
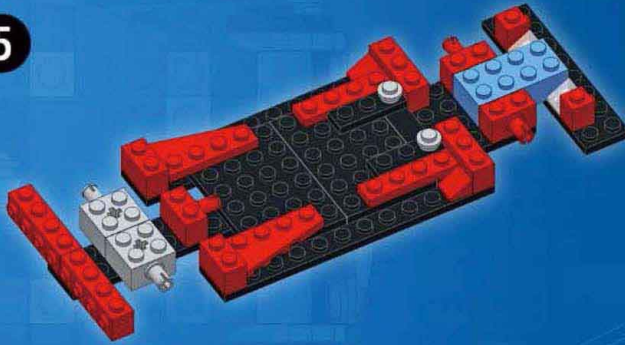

6

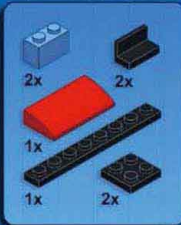

7

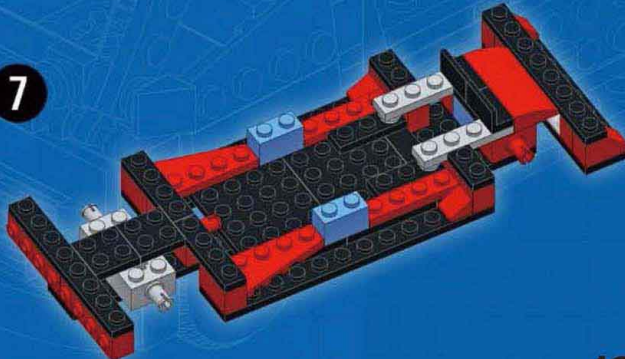

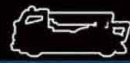

8

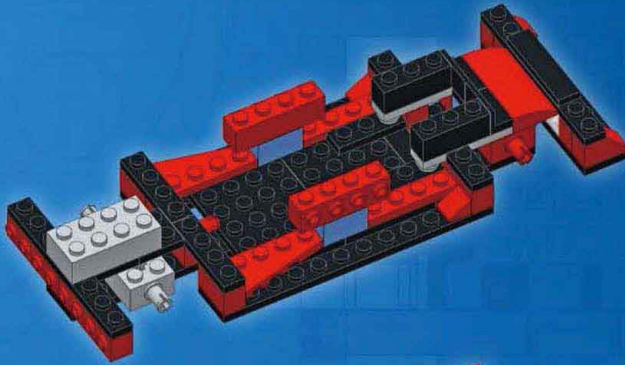
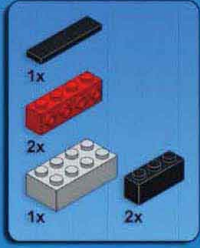

9

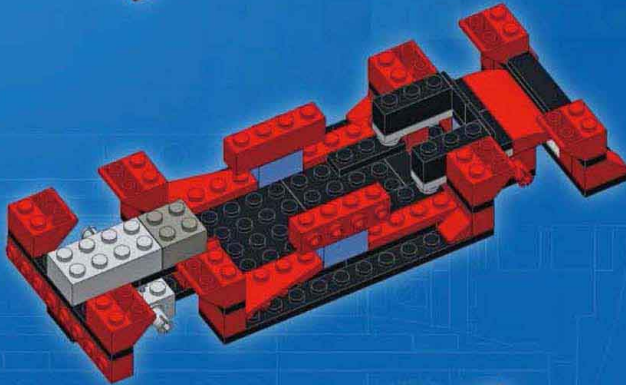

10





11

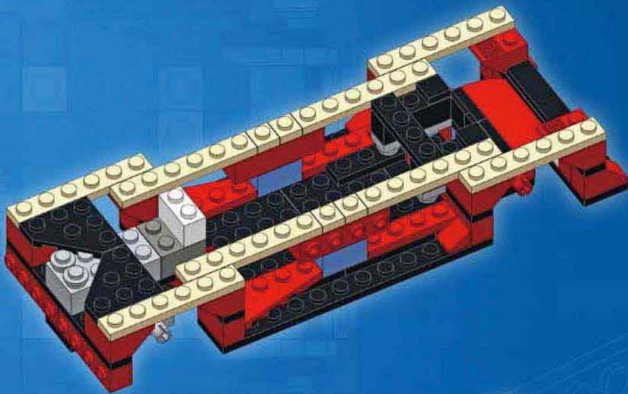
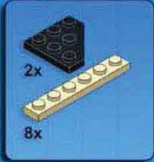

12

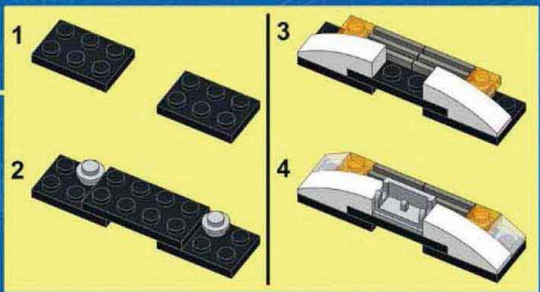
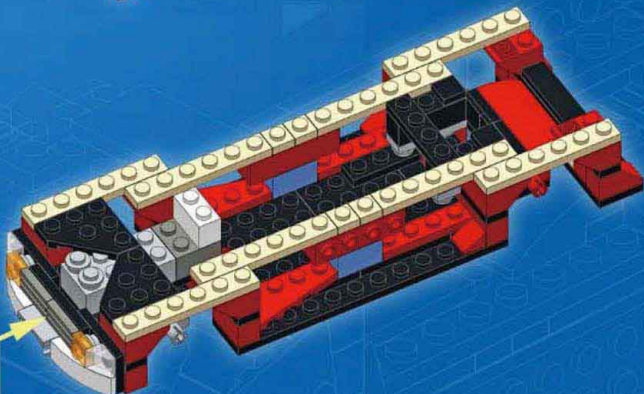

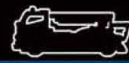

13

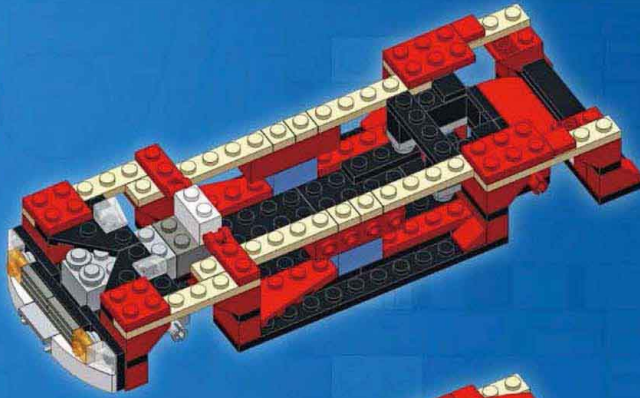
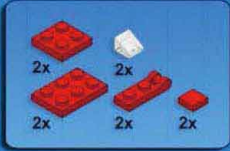

14

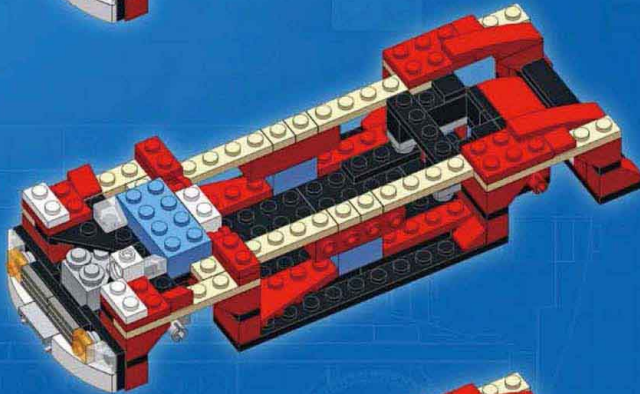
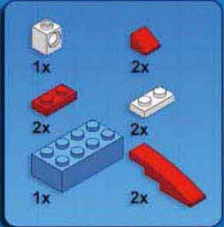

15

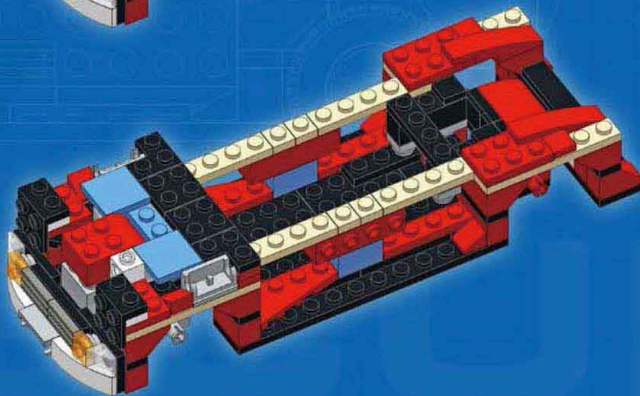
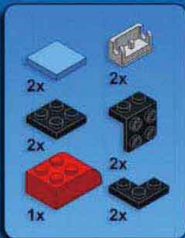



16

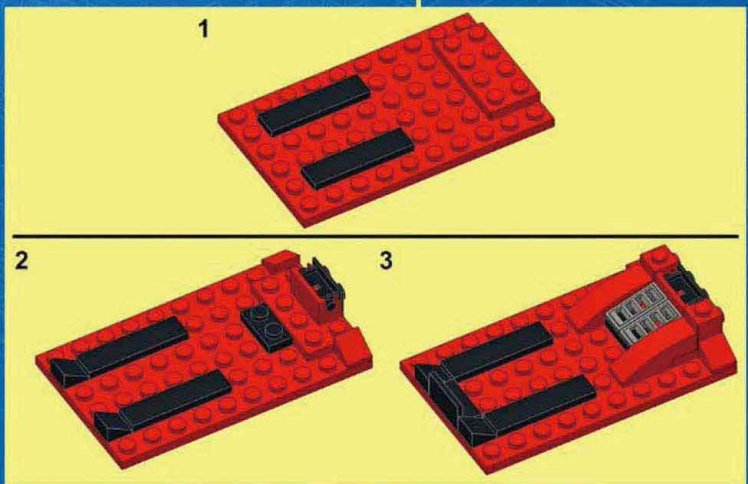
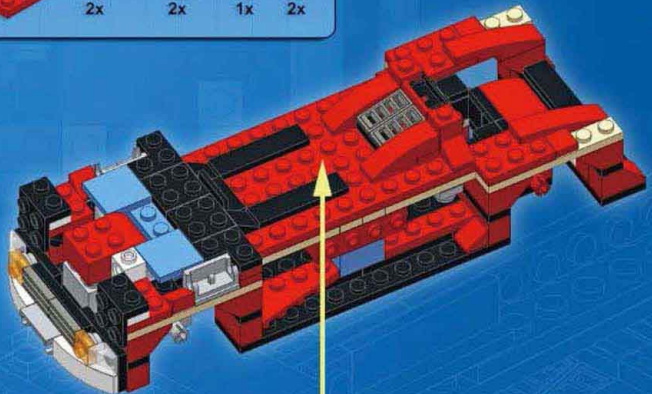
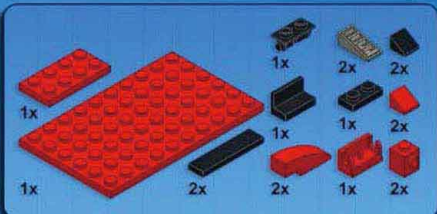



17

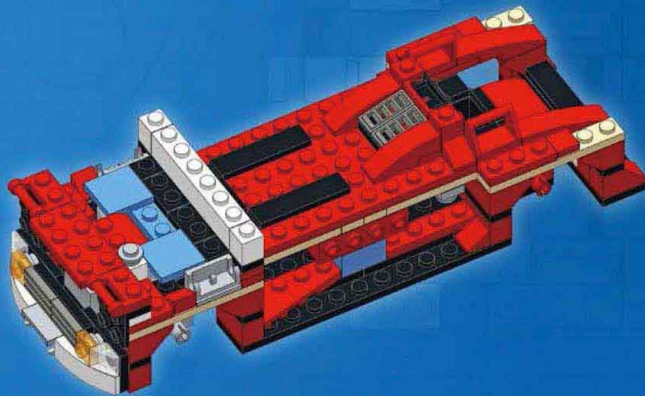
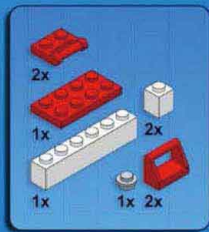

18

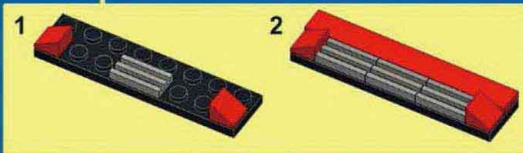
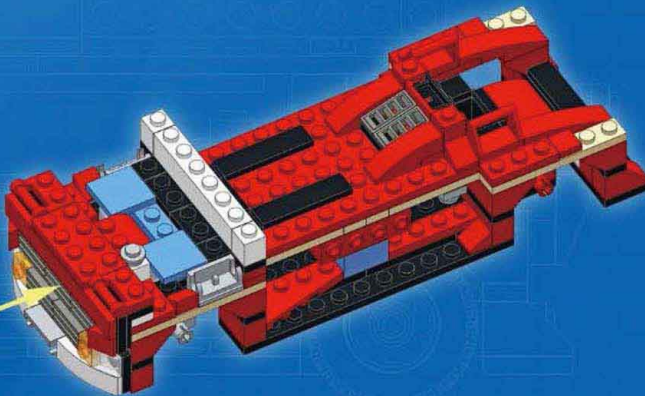
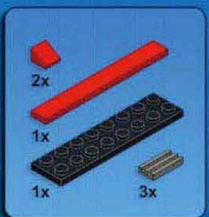



19

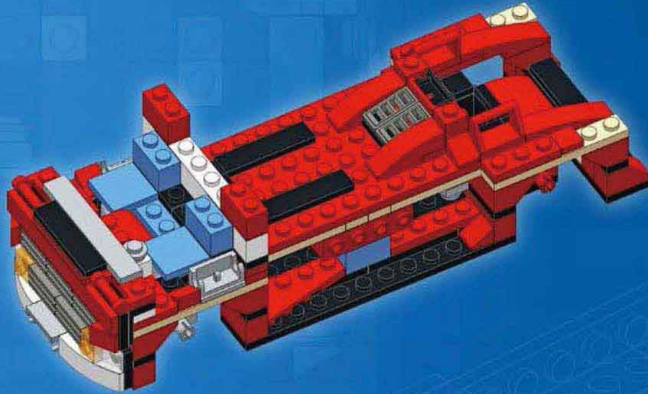
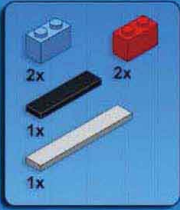

20

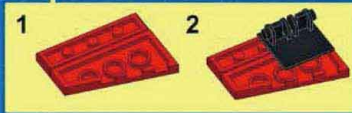
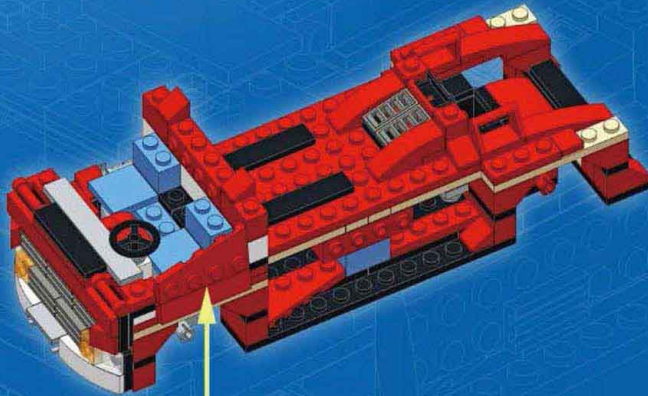
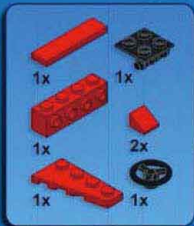

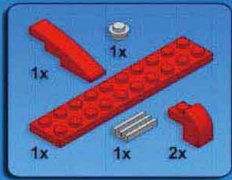

21

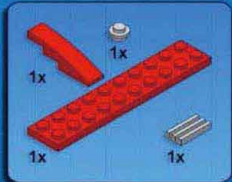
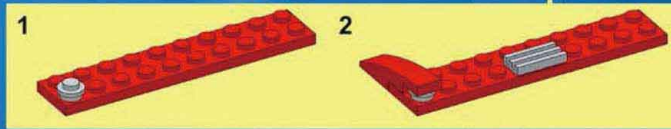
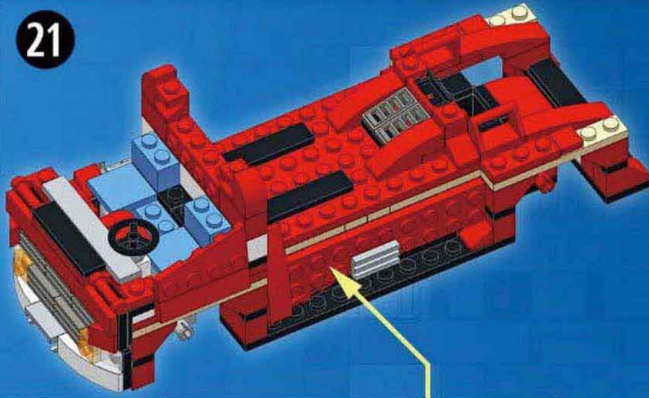

22

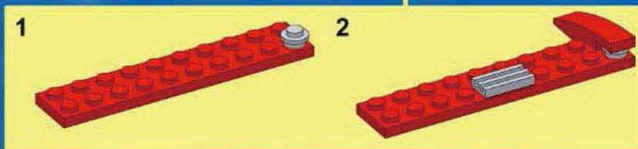
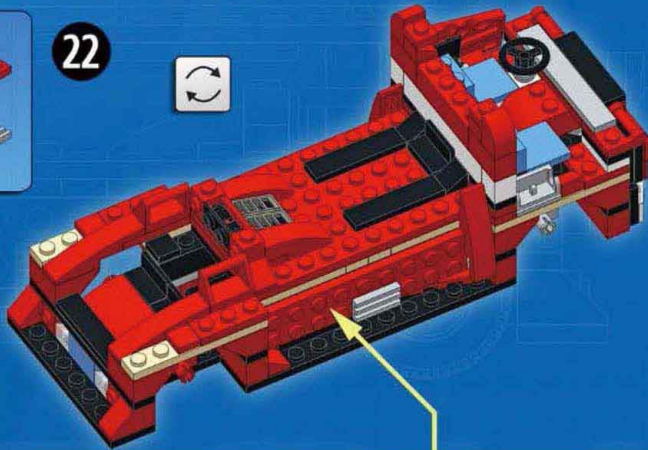



23

- 1x [black 1x2 Technic plate]
- 1x [red 1x2 Technic Technaxx]
- 1x [red 1x2 Technic Technaxx]
- 1x [red 1x2 Technic Technaxx]
- 2x [red 1x2 Technic Technaxx]



- x2 [red 1x2 Technic Technaxx]

- 1 [red 1x2 Technic Technaxx]
- 2 [black 1x2 Technic Technaxx]

- 1 [red 1x2 Technic Technaxx]
- 2 [black 1x2 Technic Technaxx]
- 3 [red 1x2 Technic Technaxx]
- 4 [black 1x2 Technic Technaxx]

24

- 2x [red 1x2 Technic Technaxx]
- 1x [black 1x2 Technic Technaxx]
- 1x [red 1x2 Technic Technaxx]
- 1x [red 1x2 Technic Technaxx]
- 1x [white 1x2 Technic Technaxx]
- 1x [black 1x2 Technic Technaxx]
- 2x [red 1x2 Technic Technaxx]

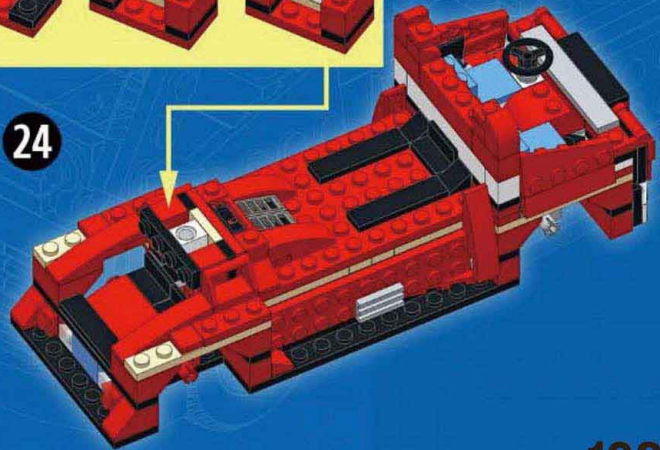

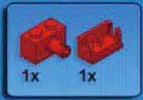

25

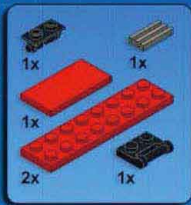
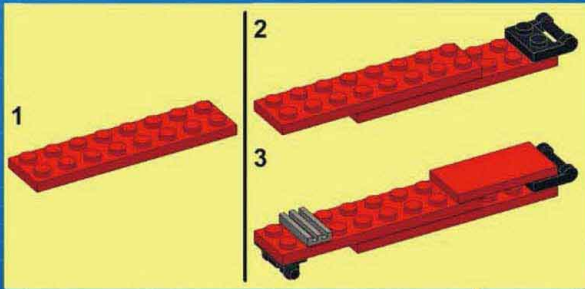
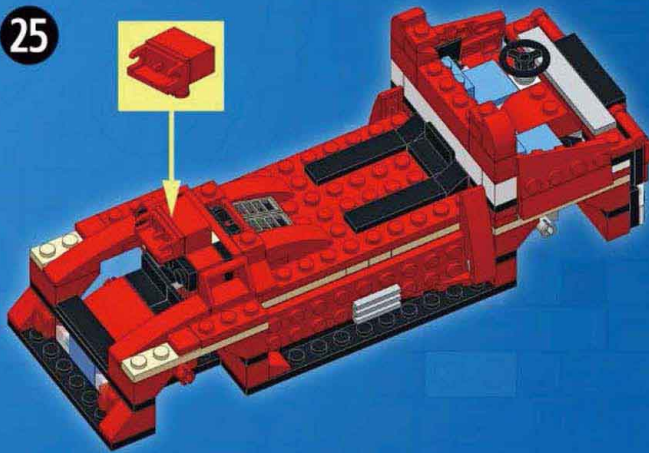

26

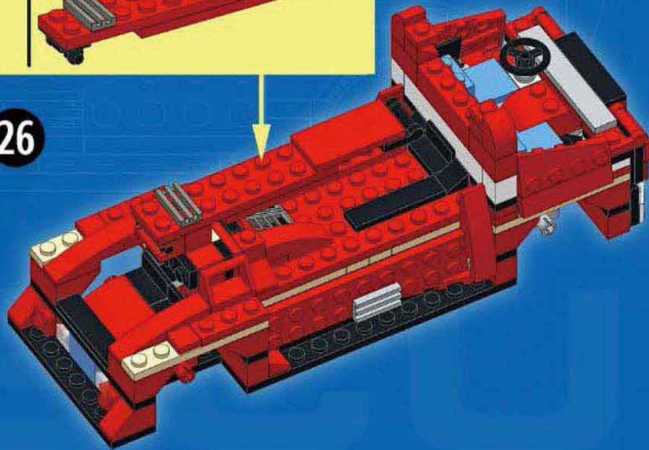



27

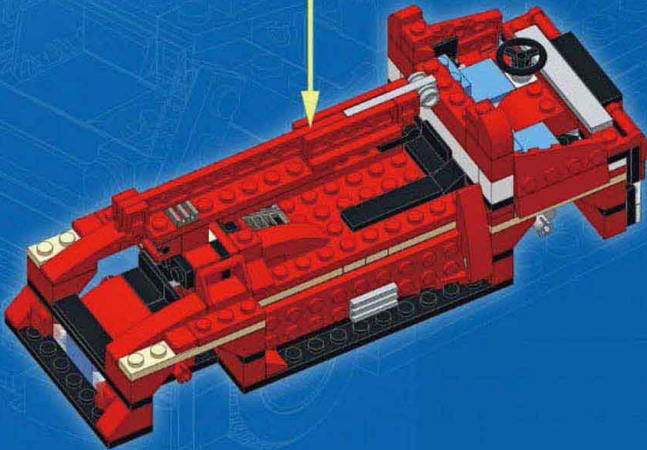
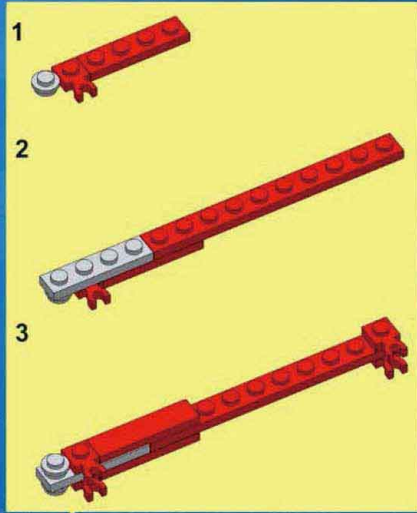
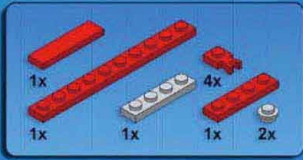

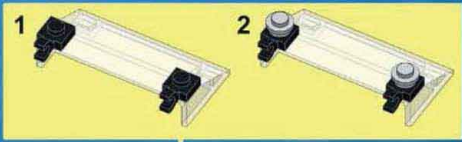

29

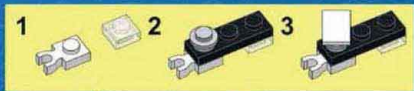
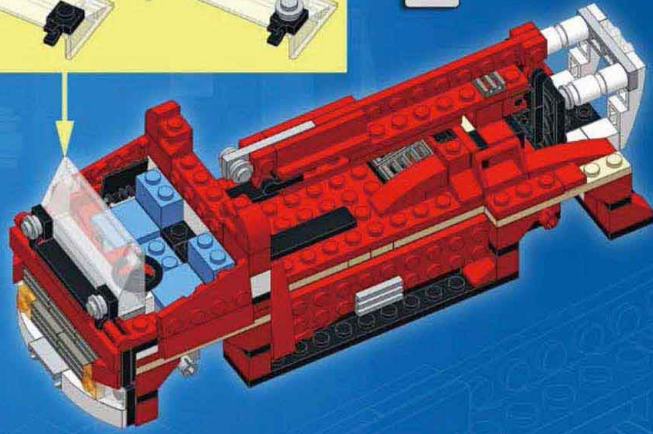

30

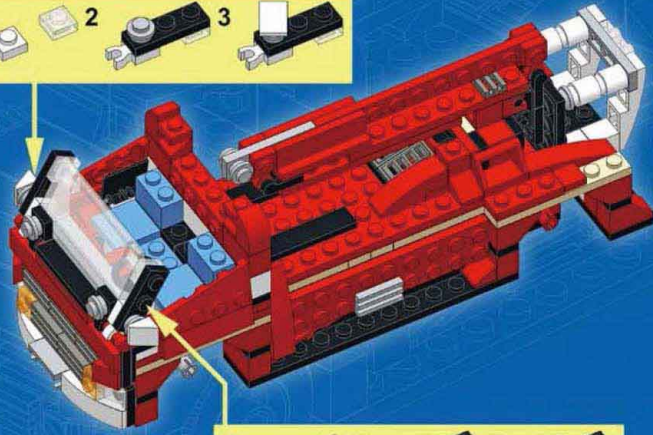



31

- 2x
- 2x
- 1x
- 1x
- 1x
- 1x
- 2x
- 1x
- 1x
- 2x

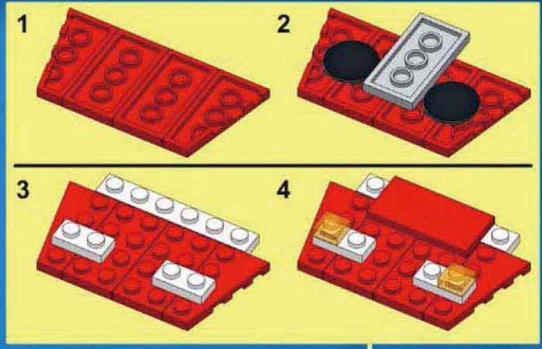

32

- 4x
- 4x





Complexity
Functions 
Pieces 

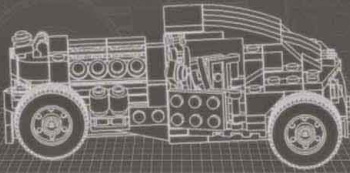
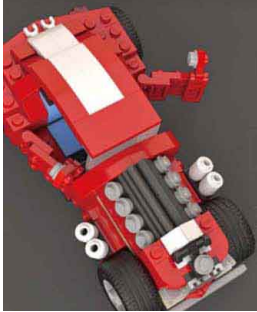
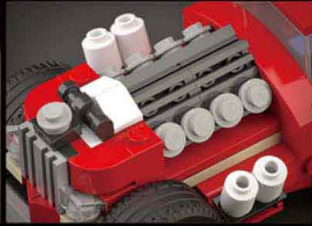

HOT ROD

Design notes: chop top, exposed V8 engine, big exhaust pipes, wide rear axle

Technical specifications:
Dimensions (l x w x h): 18 x 10 x 8 studs
Wheelbase: 13 studs
Axle width front/rear: 8/10 studs

Features: opening doors

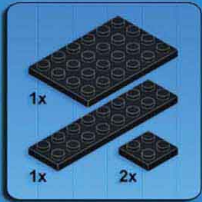

1

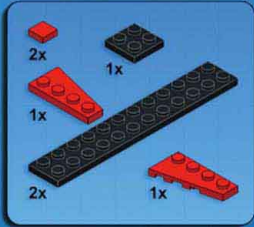
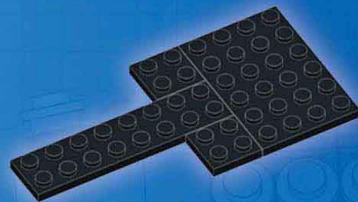

2

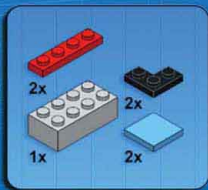
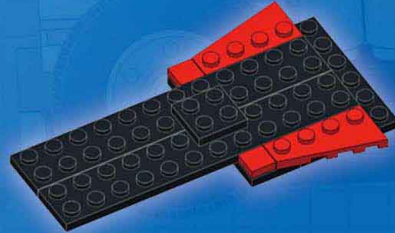

3

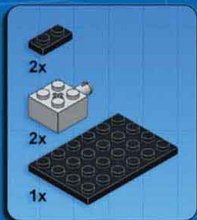
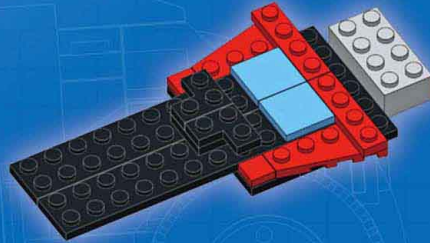

4

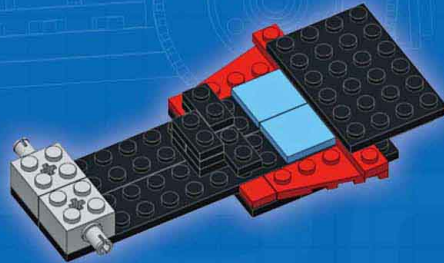



5

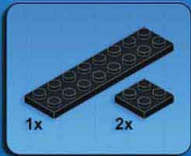
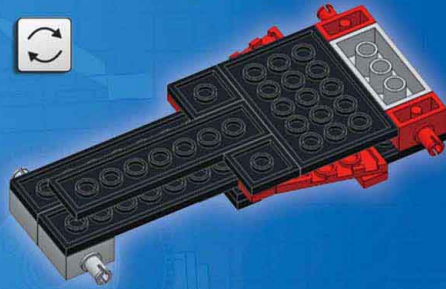

6

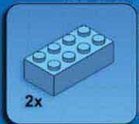
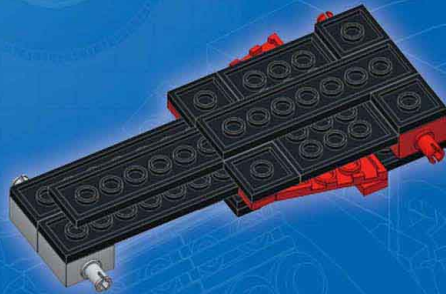

7

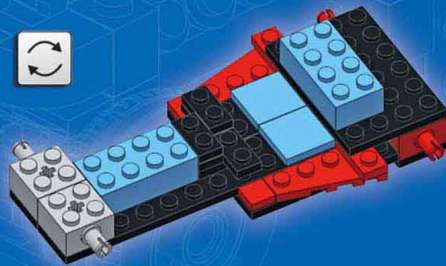



8

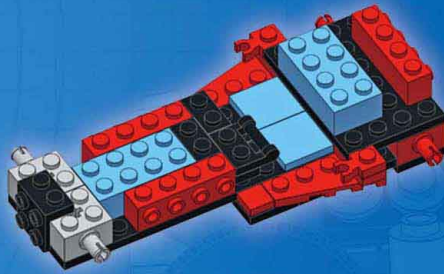
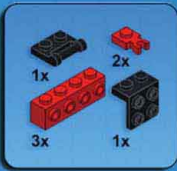

9

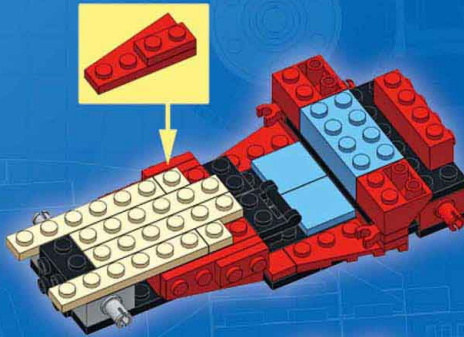
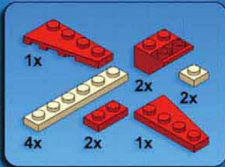

10

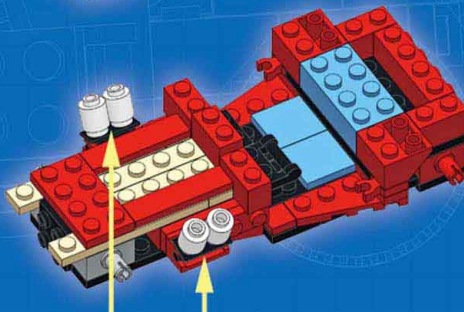
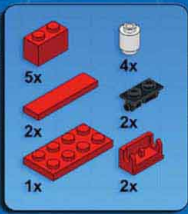

11

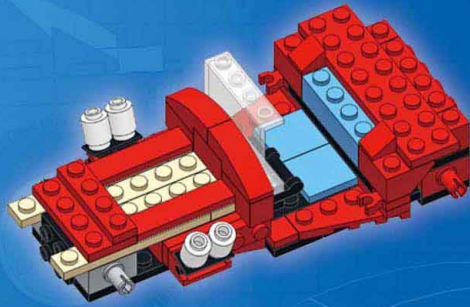
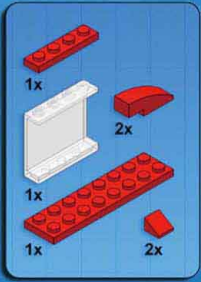

12

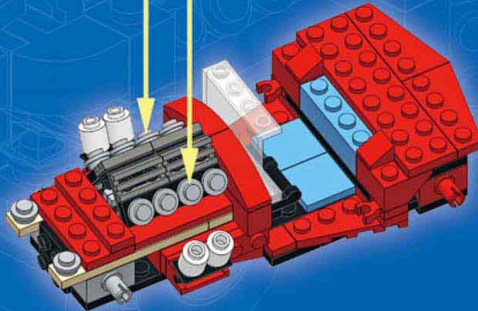
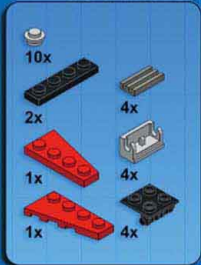



13

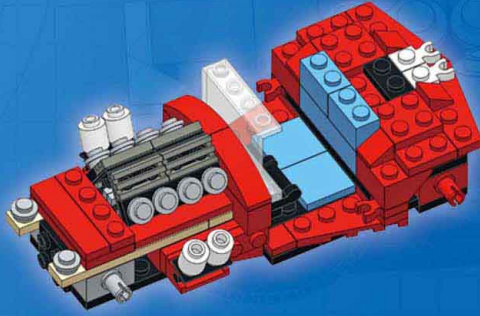
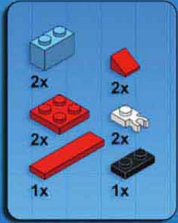

14

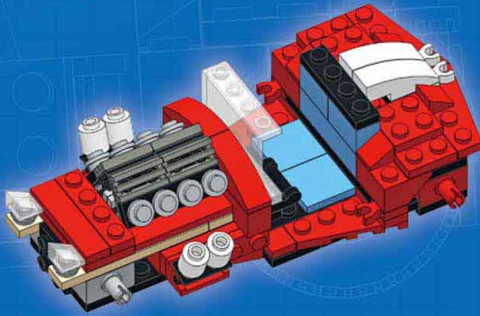

15

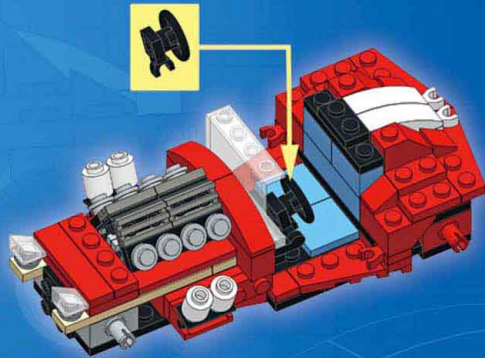

16

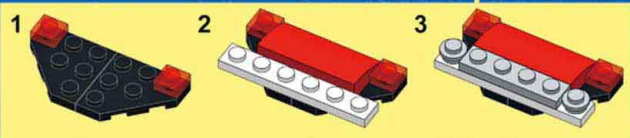
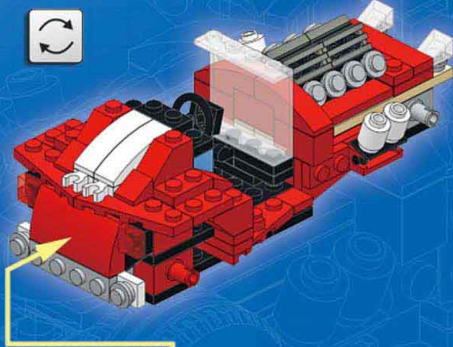
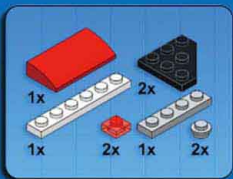



17

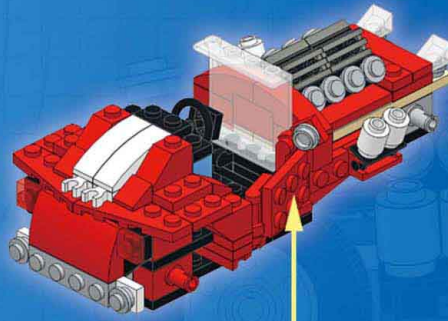
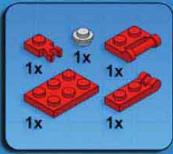

18

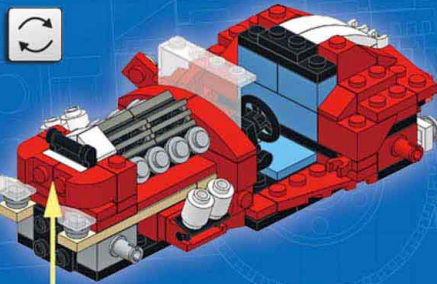
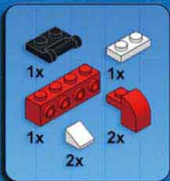

19

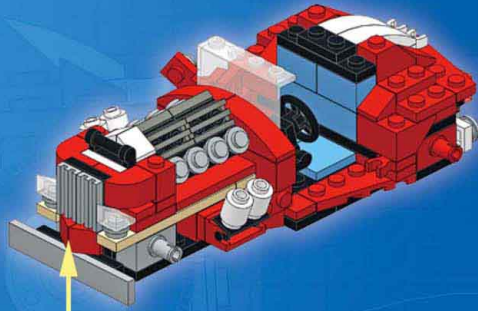
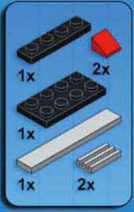

20

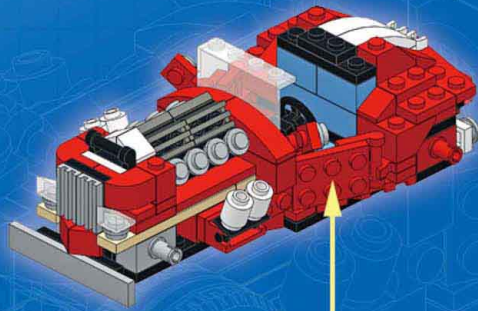
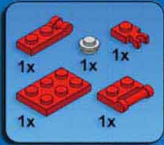

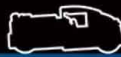

21

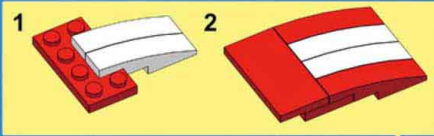

x2

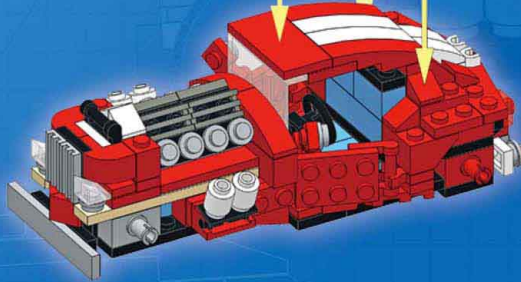
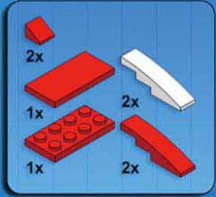

22

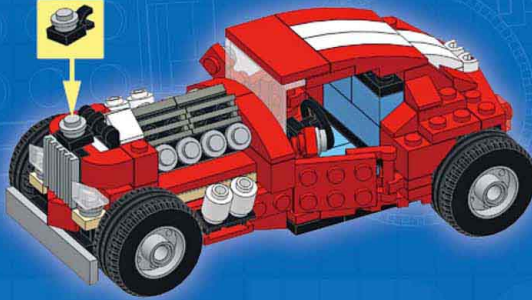



Complexity 
Functions 
Pieces 

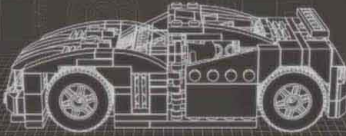
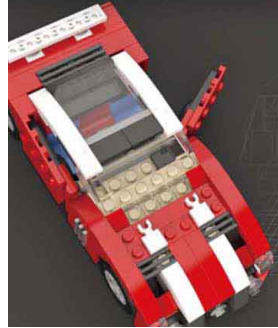
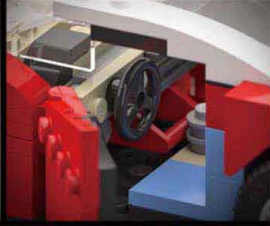

GRAN TURISMO

Design notes: low chassis, aerodynamic shape, sophisticated lines, racing stripes, spoiler

Technical specifications:
Dimensions (l x w x h): 20 x 9 x 7 studs
Wheelbase: 12 studs
Axle width front/rear: 8/8 studs

Features: opening doors



1

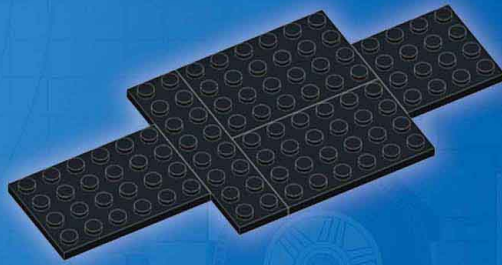
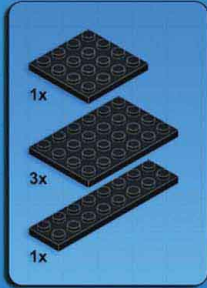

2

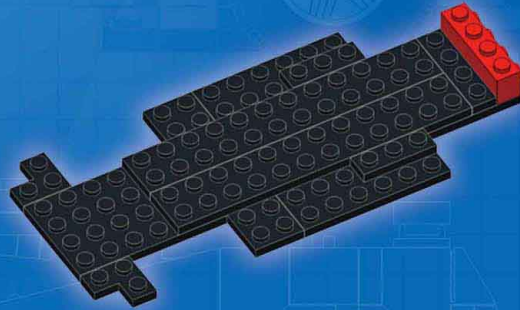
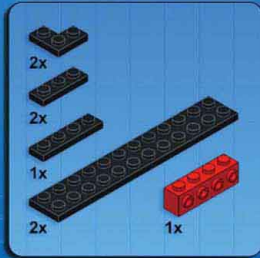

3

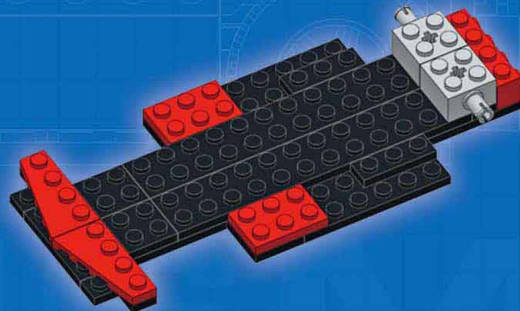
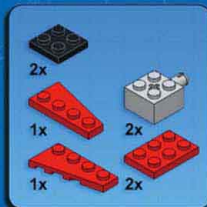



4

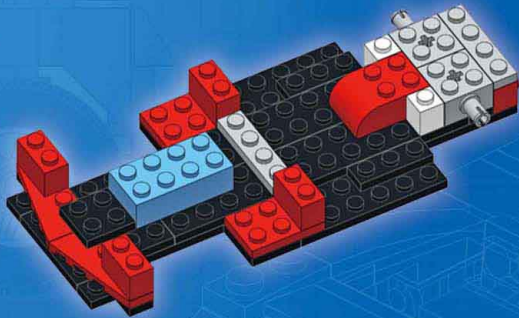
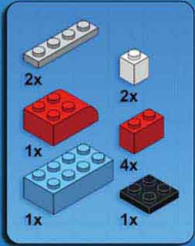

5

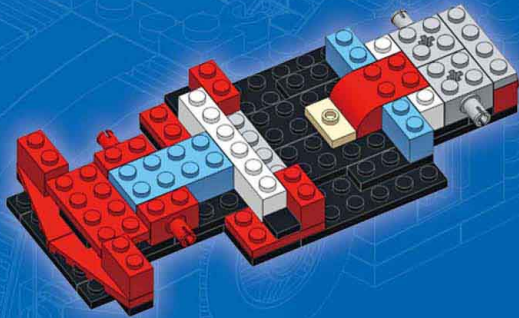
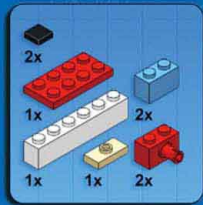



6

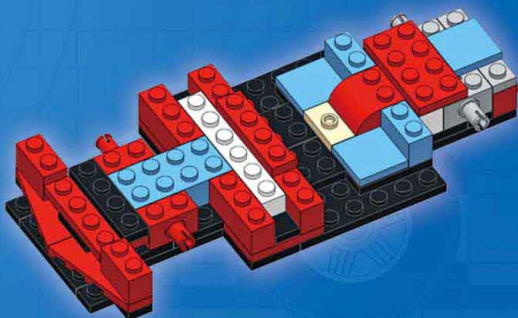
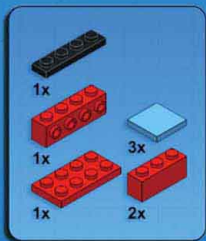

7

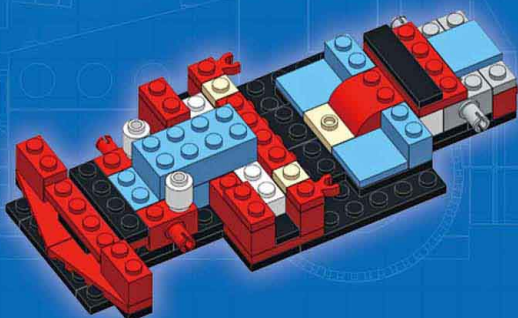
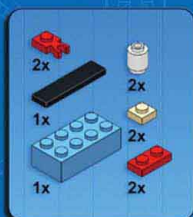



8

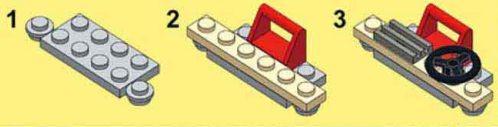
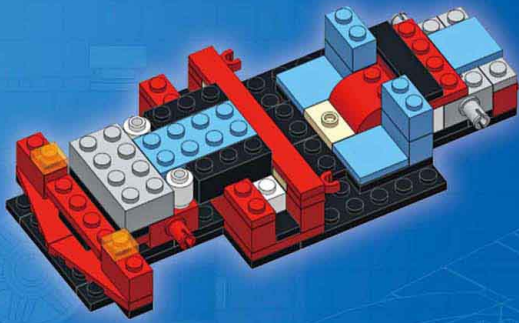
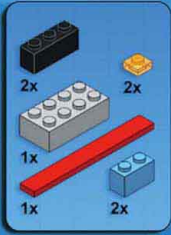

9

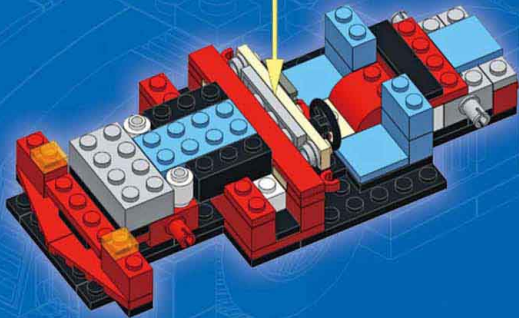



10

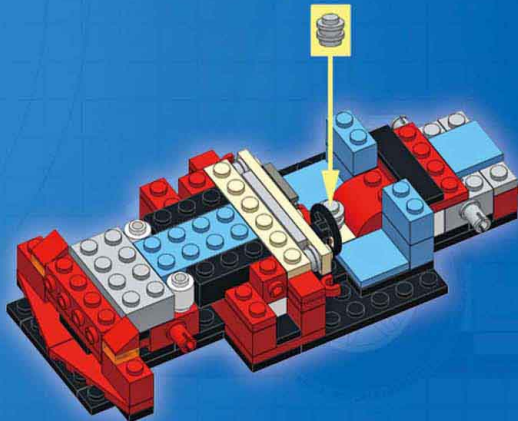
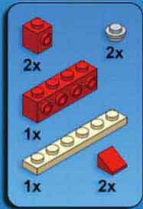

11

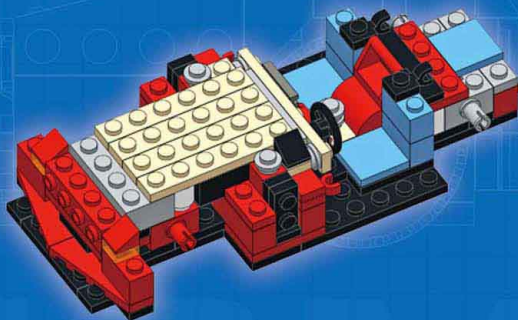
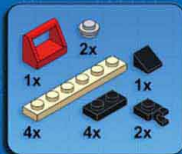



12

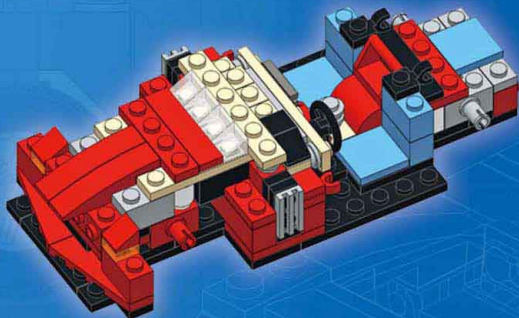
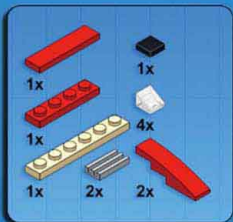

13

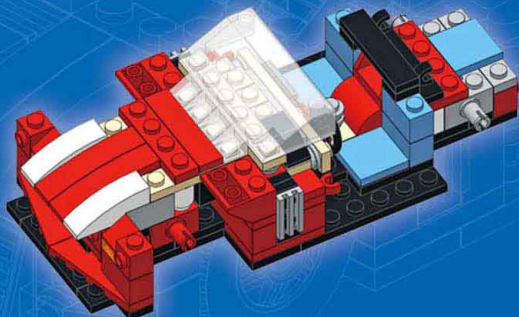
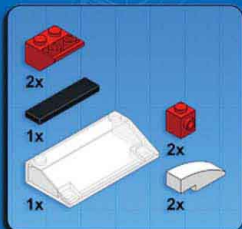



14

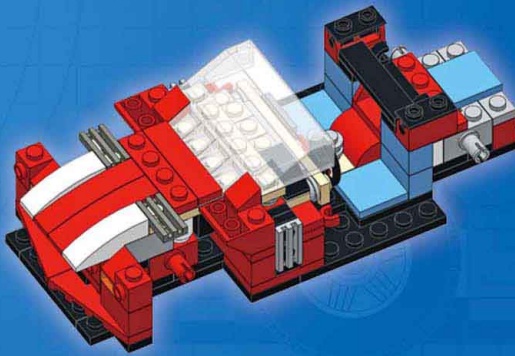

15

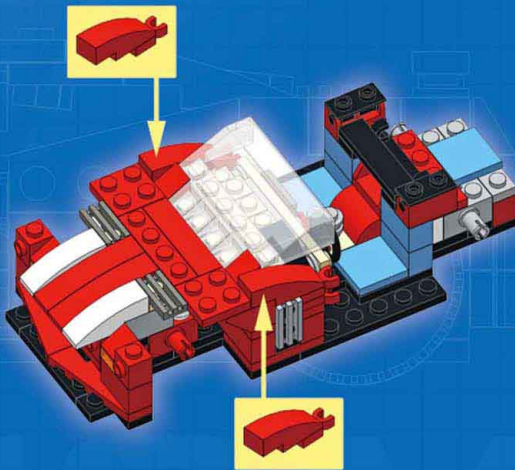
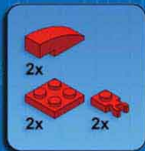



16

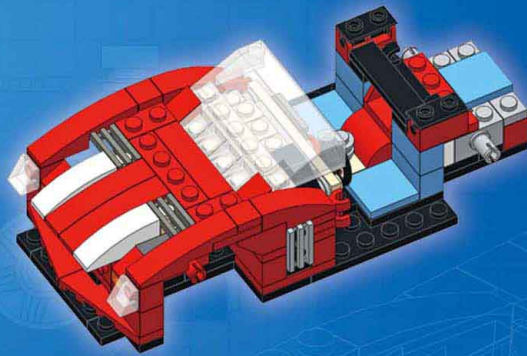
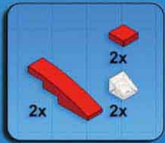

17

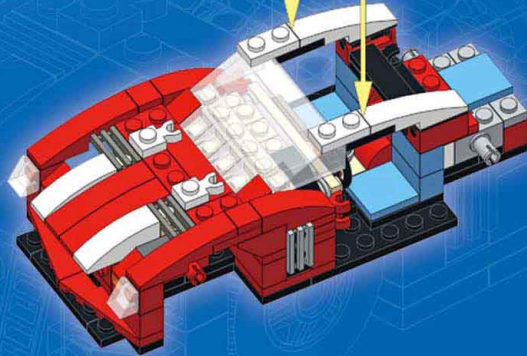
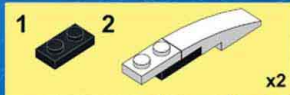



18

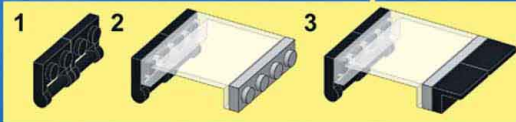
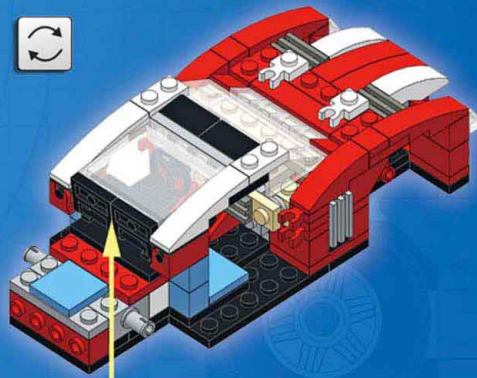
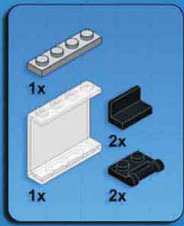

19

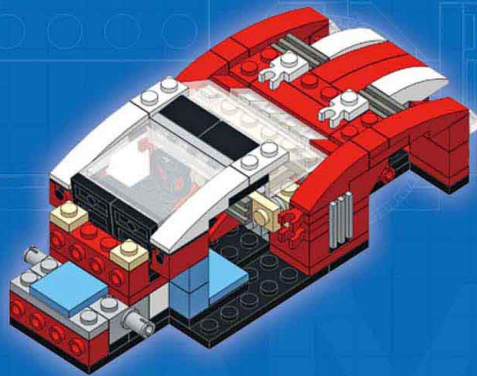



20

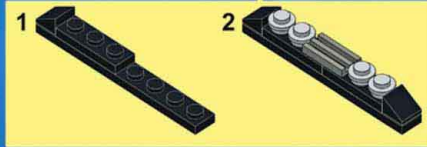
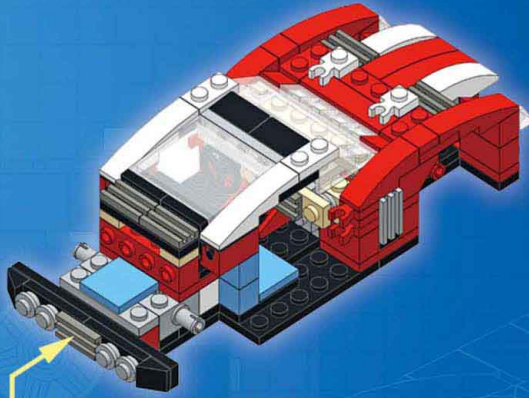
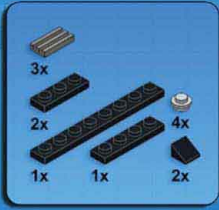

21

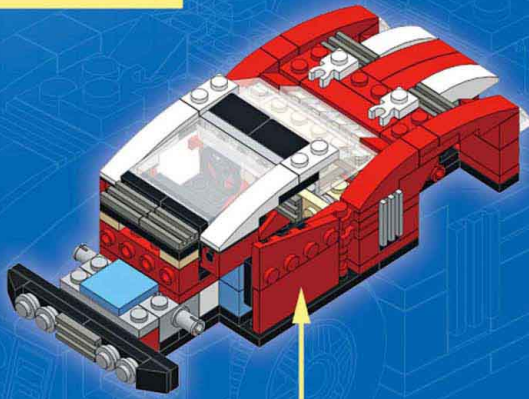
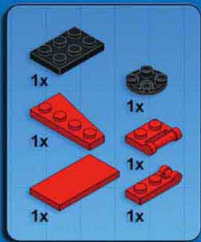



22

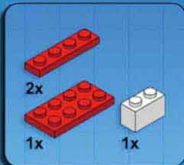

1

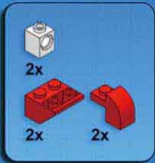
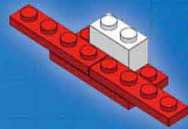

2

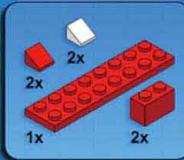
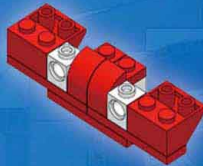

3

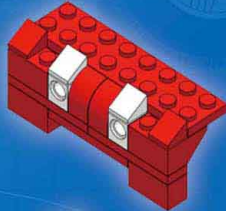

4

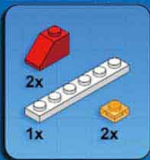
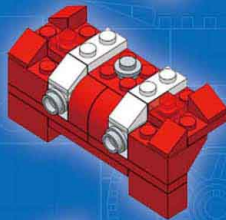

5

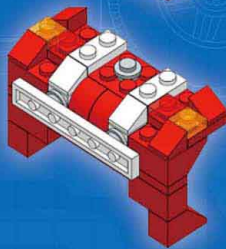

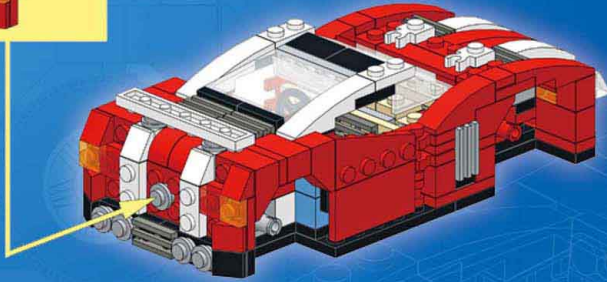
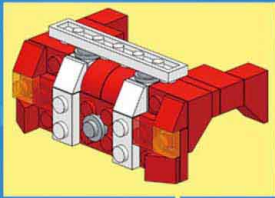

23

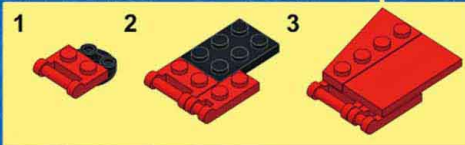
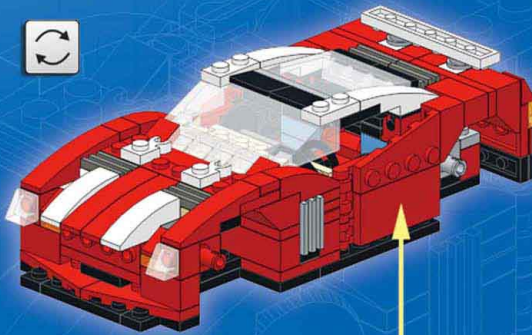
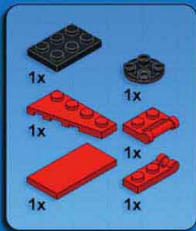



24

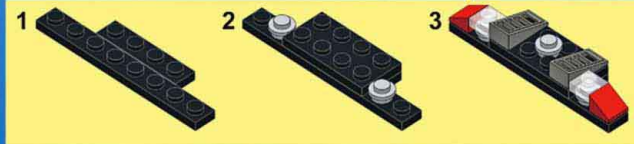
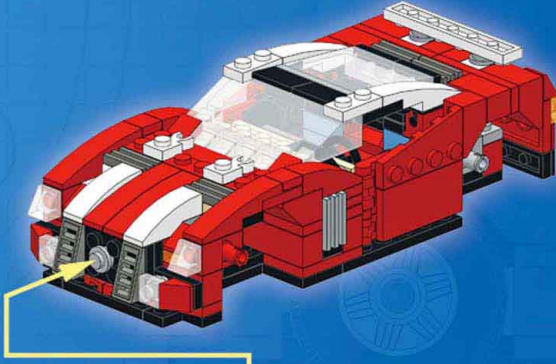
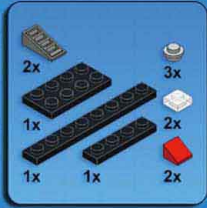

25

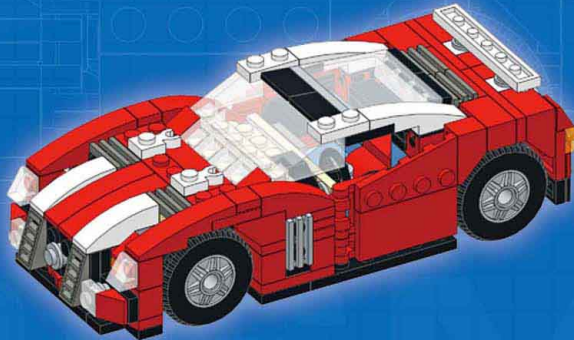



Complexity 
Functions 
Pieces 

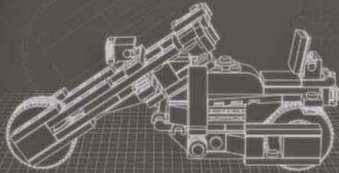
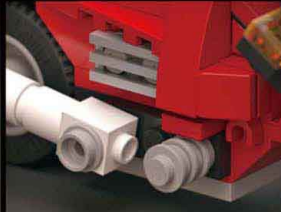

CHOPPER

Design notes: 4-cylinder engine, high handlebars, big headlight, gas tank, easy rider seat

Technical specifications:
Dimensions (l × w × h): 18 × 9 × 9 studs
Wheelbase: 14 studs
Axle width front/rear: 4/3 studs

Features: working steering

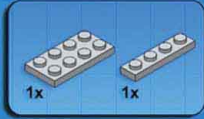

1



2

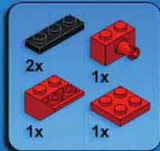
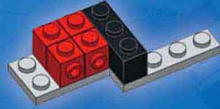

3

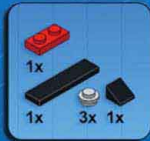
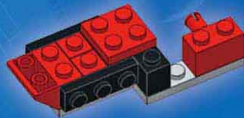

4

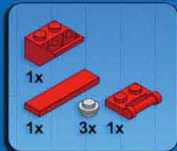
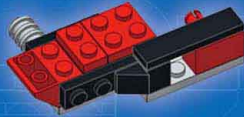

5

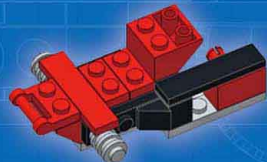



6

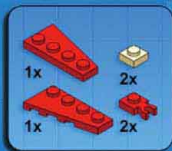

7

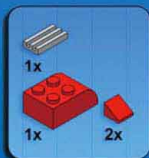
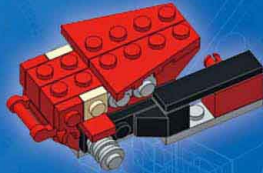

8



9





10

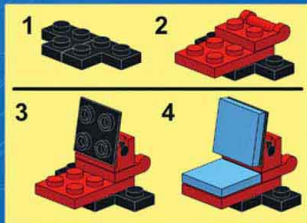
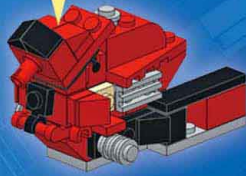
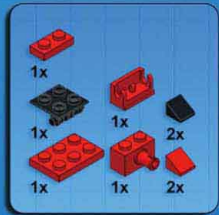

11

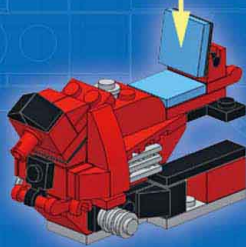
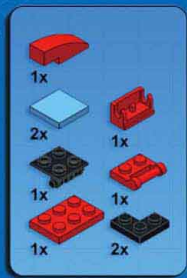

12

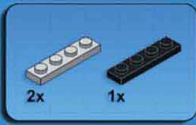

1

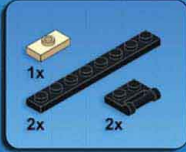
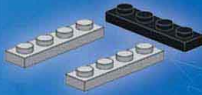

2

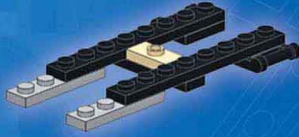

3

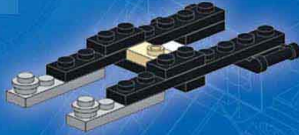

4

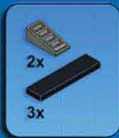
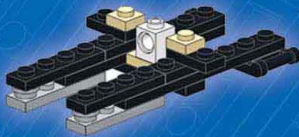

5

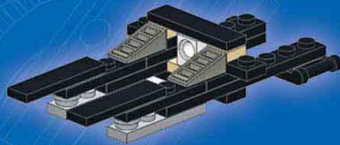



6

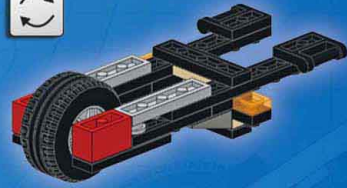

7

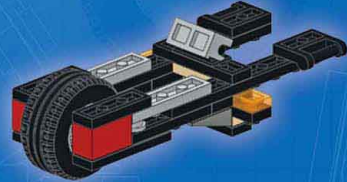
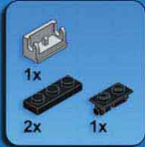

8

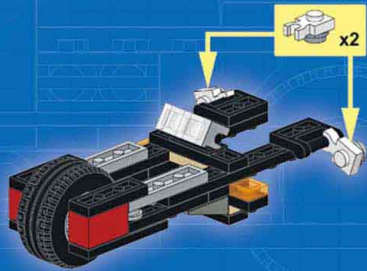

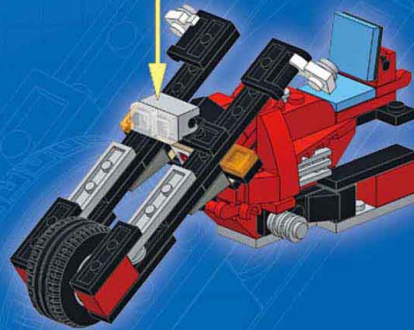



13



14

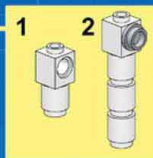
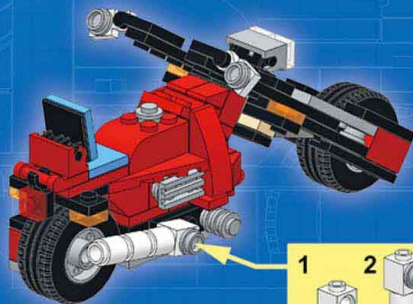



Complexity 
Functions 
Pieces 

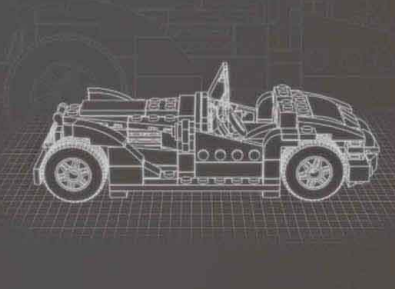
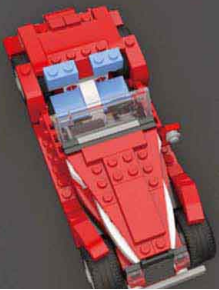
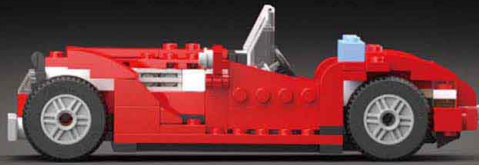

ROADSTER

Design notes: dramatic curves; open top;
long, tapered nose; classic sporty design;
detailed interior

Technical specifications:
Dimensions (l × w × h): 21 × 9 × 7 studs
Wheelbase: 14 studs
Axle width front/rear: 8/8 studs

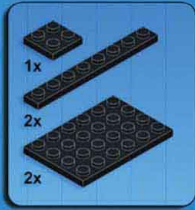

1

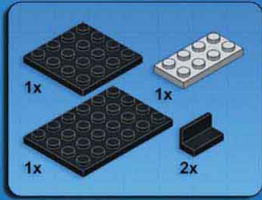

2

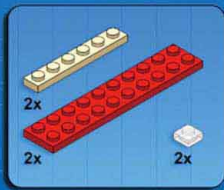

3

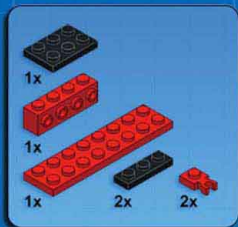
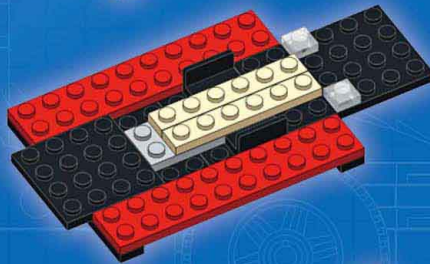

4

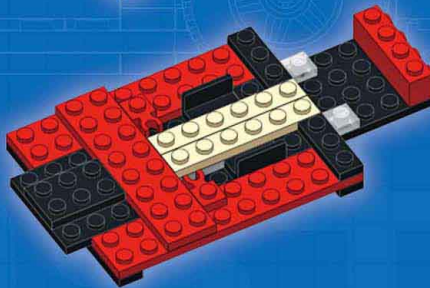

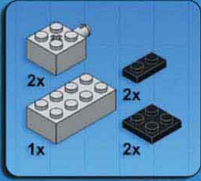

5

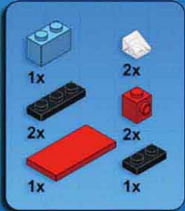
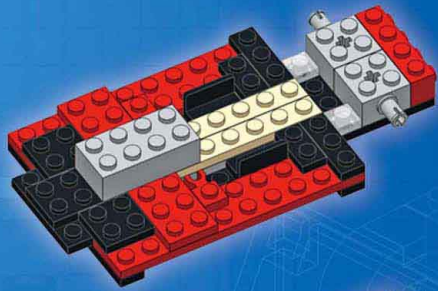

6

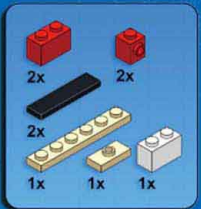
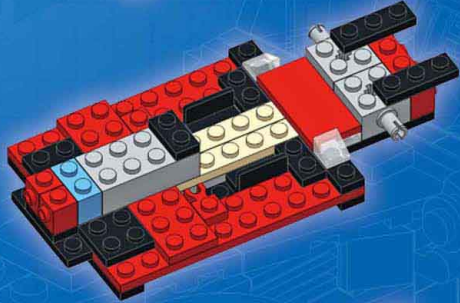

7

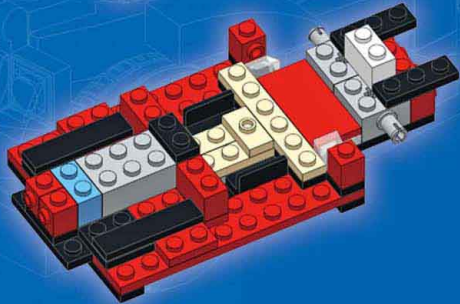



8

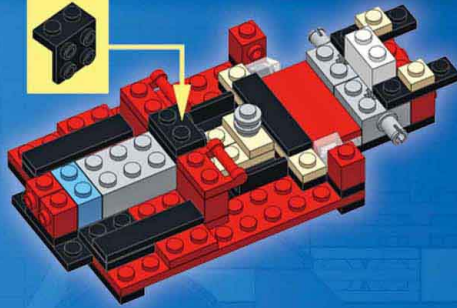
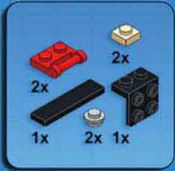

9

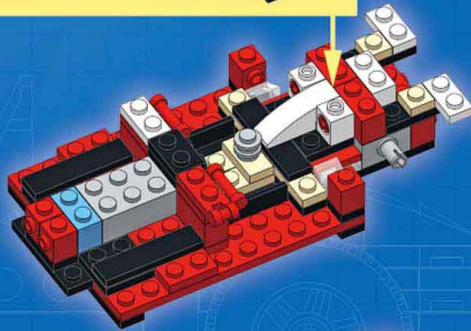
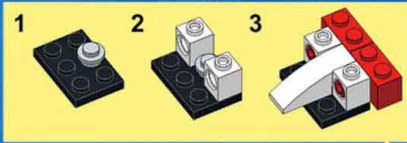
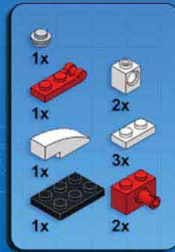

10

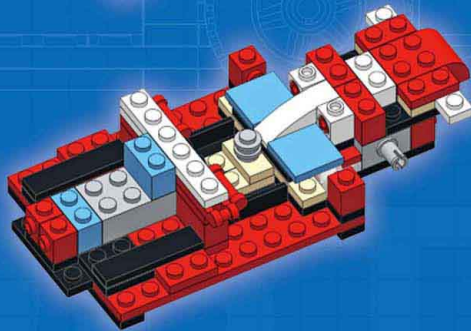
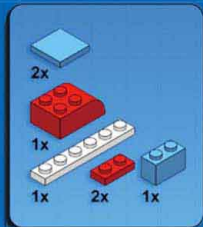



11

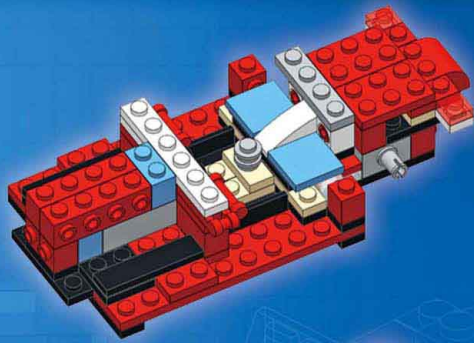
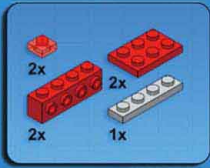

12

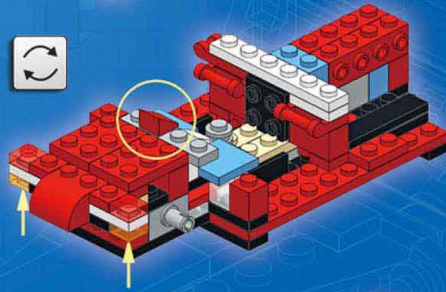

13

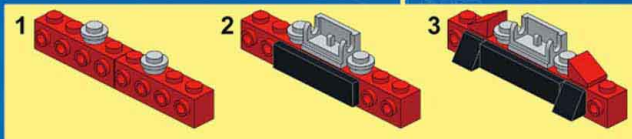
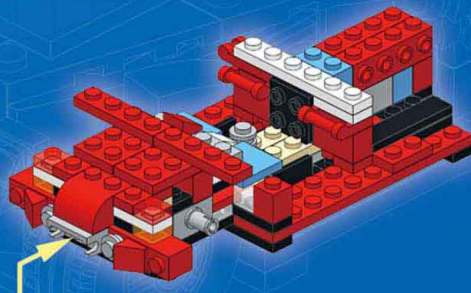
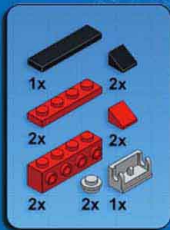



14

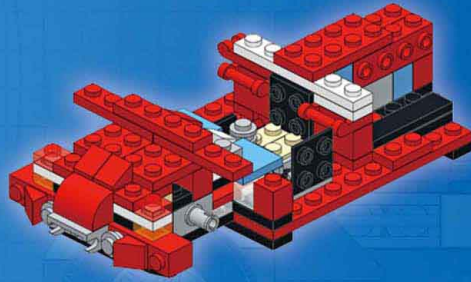
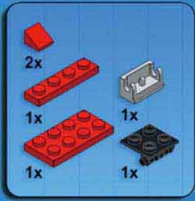

15

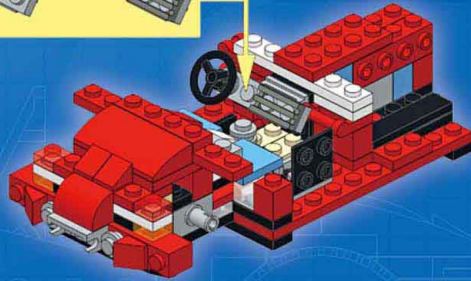

16

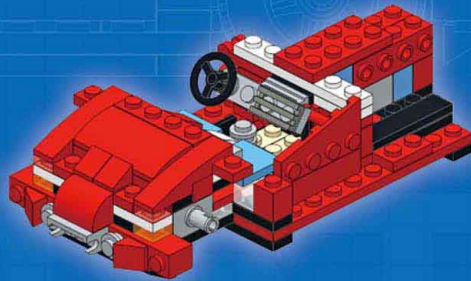
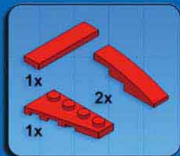

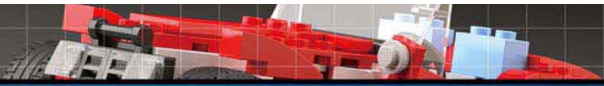

17

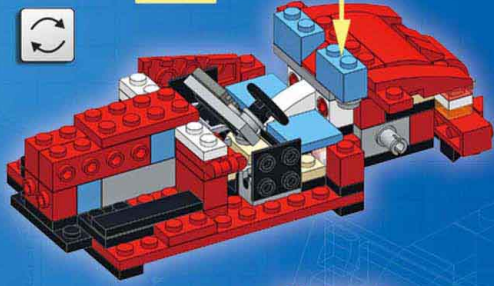

18

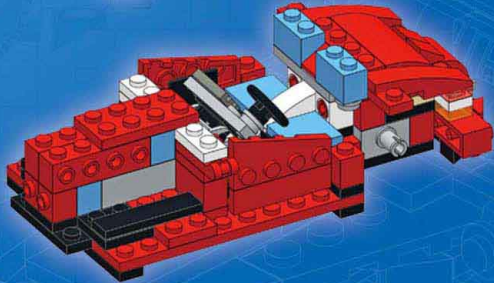
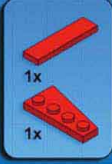

19

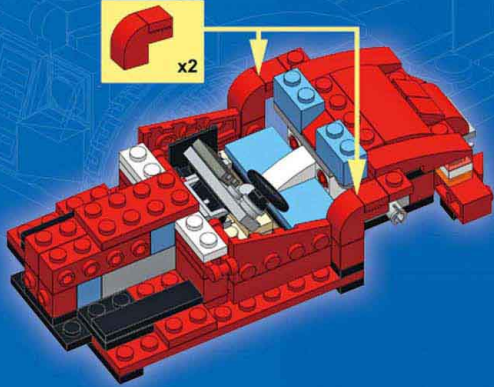



21

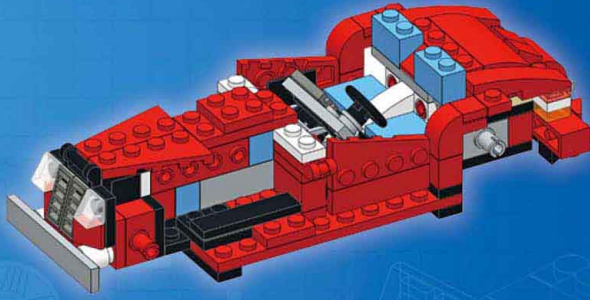
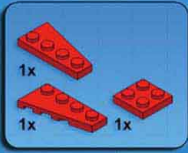

22

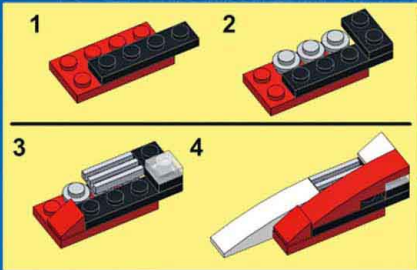
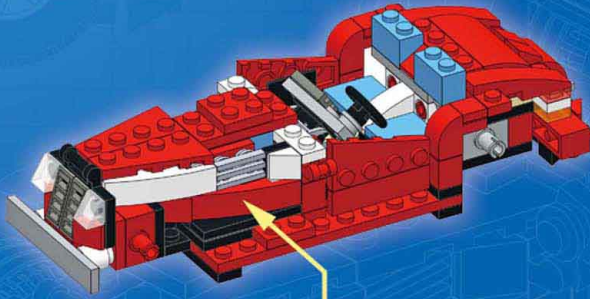
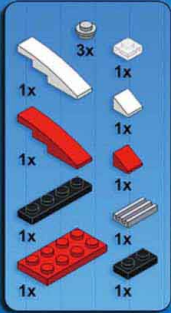



23

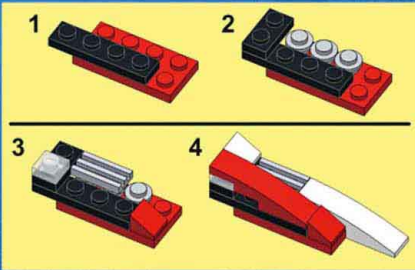
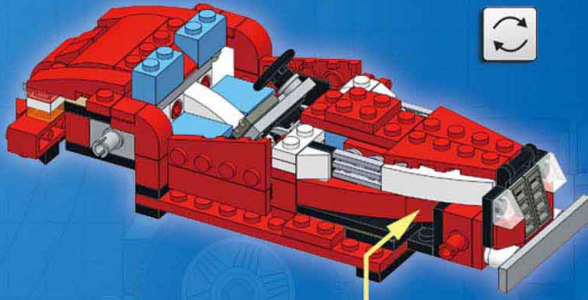
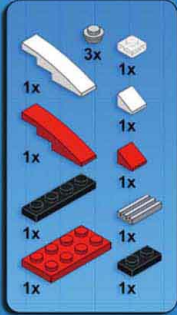

24

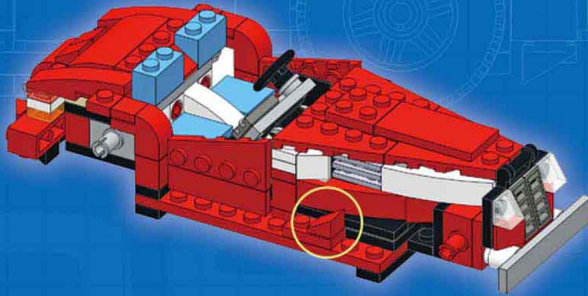
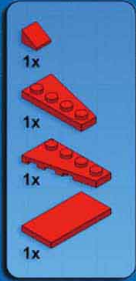



25

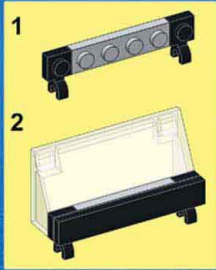
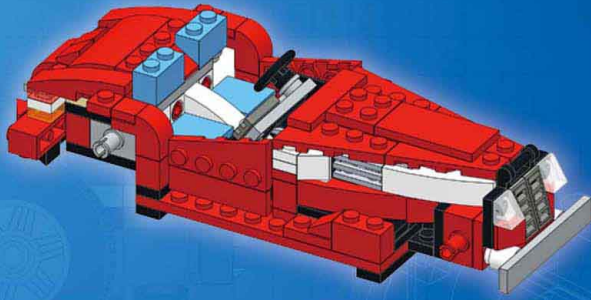
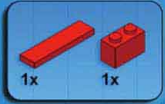

26

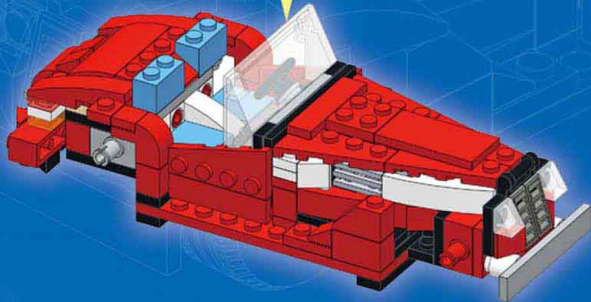
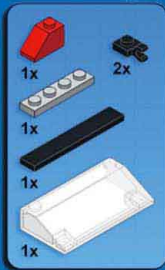



27

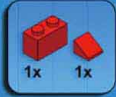
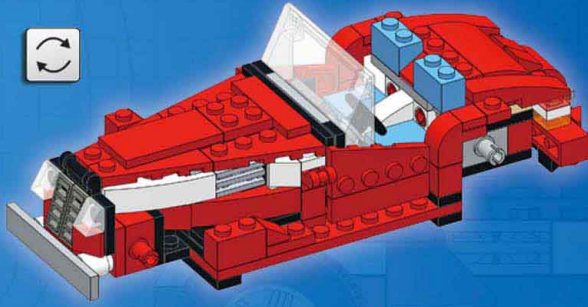

28

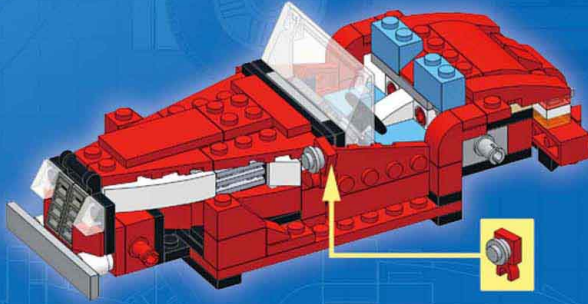

29

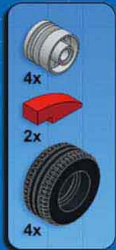
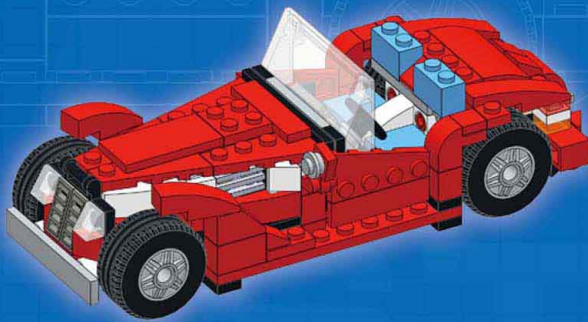



Complexity 
Functions 
Pieces 

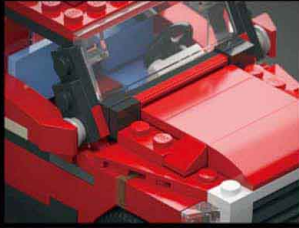

WRECKER

Design notes: long wheelbase, high clearance, flat bed, wide rear axle, massive grille, livery lines

Technical specifications:
Dimensions (l × w × h): 23 × 10 × 11 studs
Wheelbase: 14 studs
Axle width front/rear: 8/10 studs

Features: lifting crane

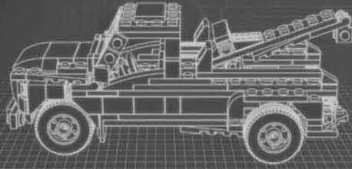
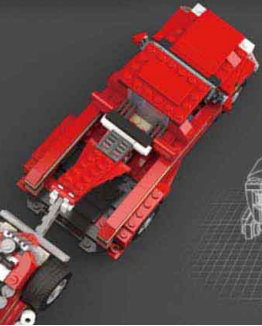

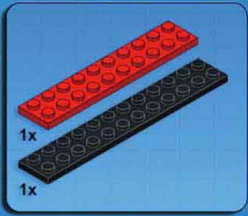

1

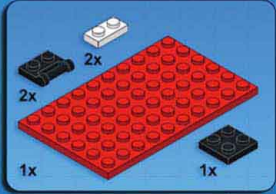
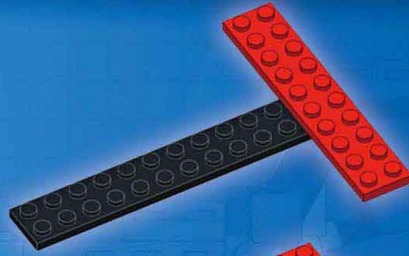

2

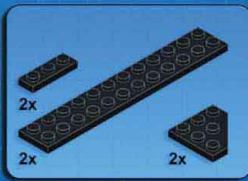
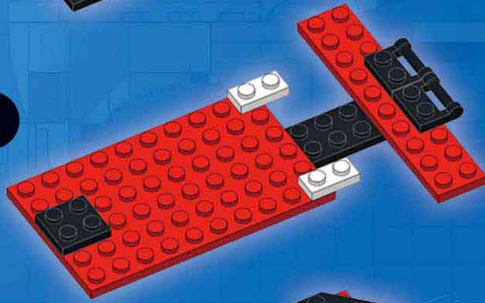

3

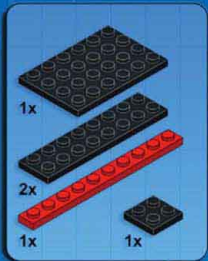
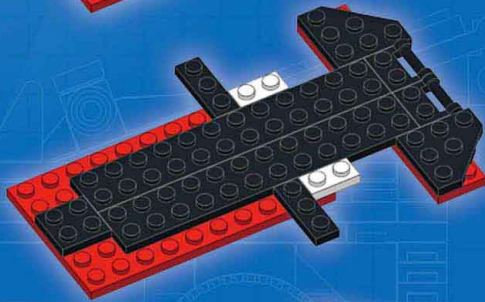

4

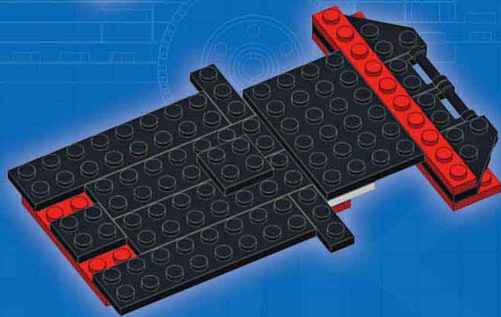

5

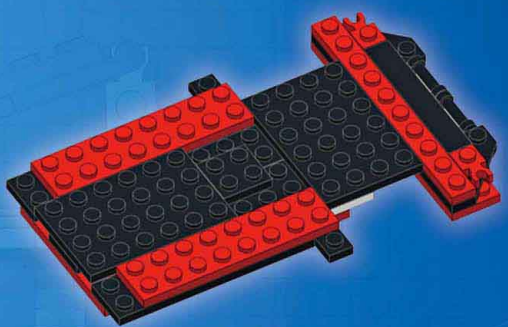
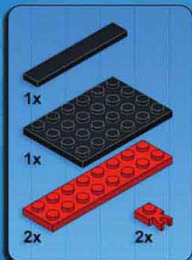

6

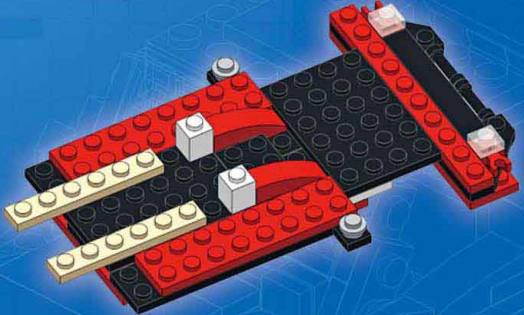
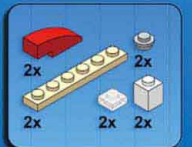

7

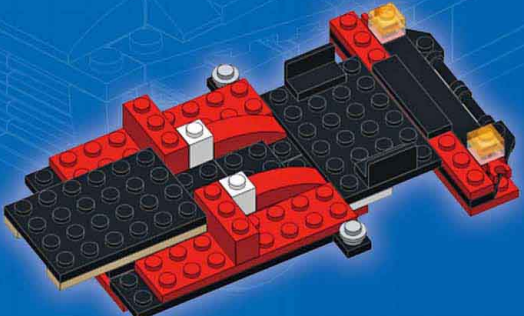
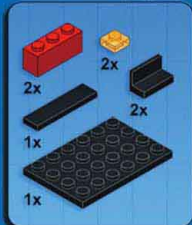



8

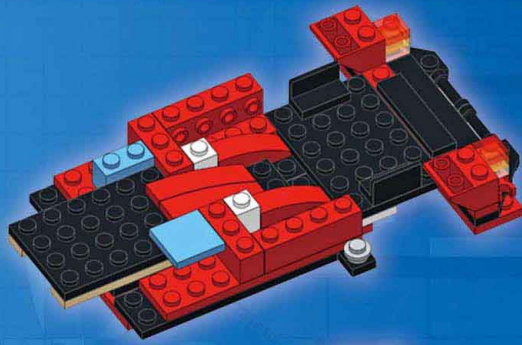
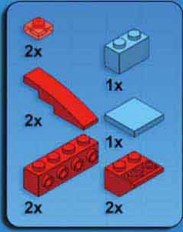

9

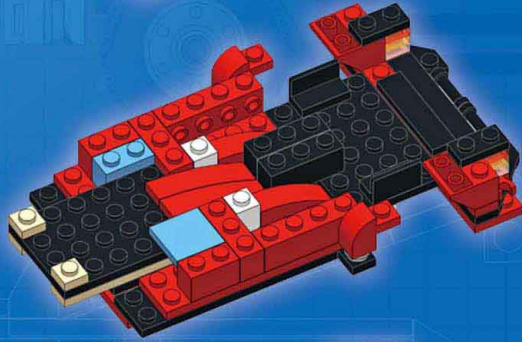
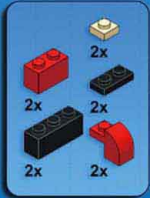

10

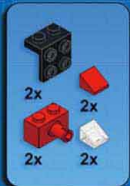

1

2

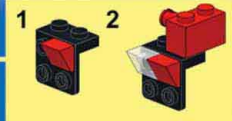
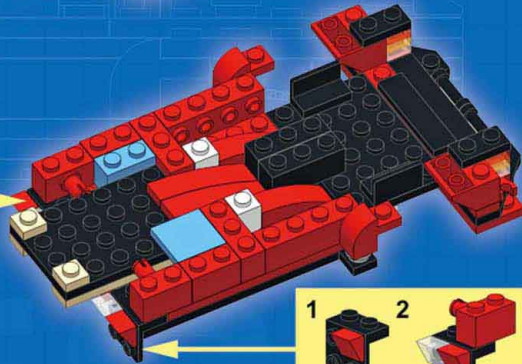

1

2



11

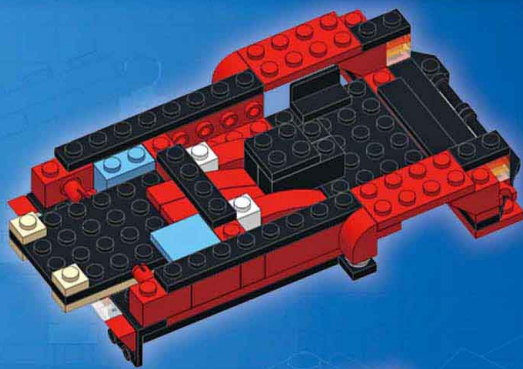
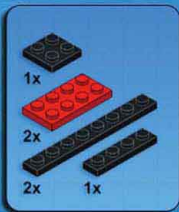

12

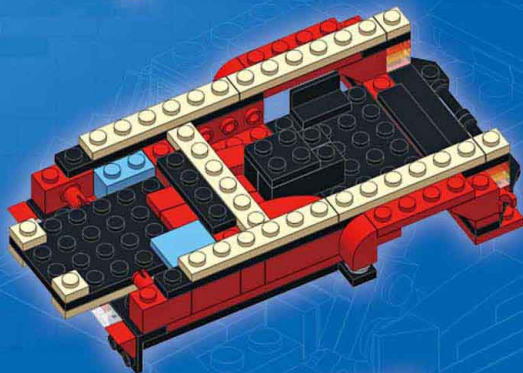
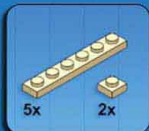

13

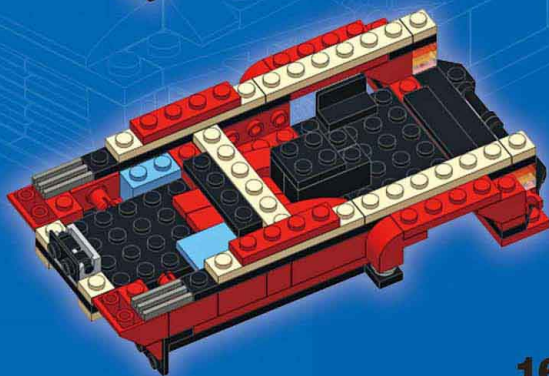
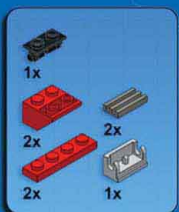



14

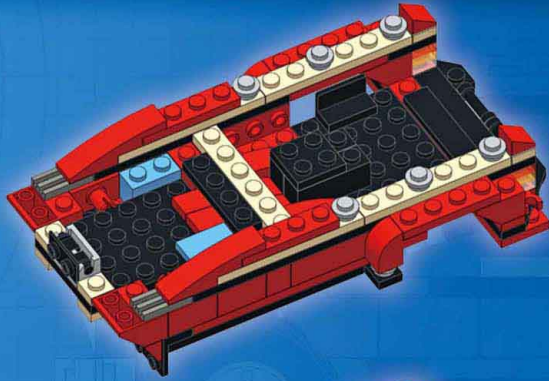
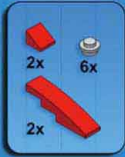

15

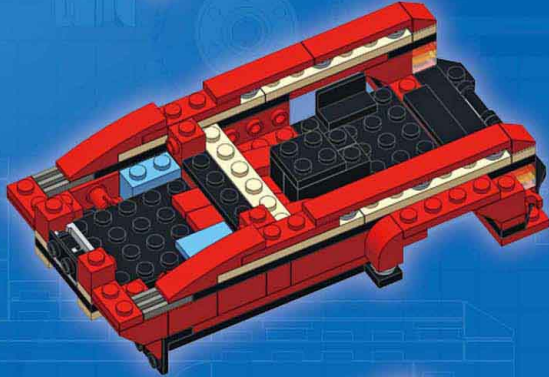
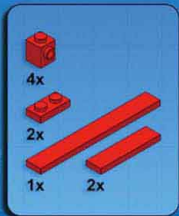

16

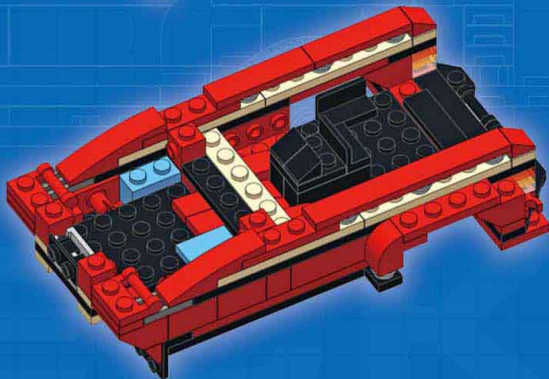
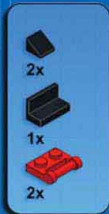



17

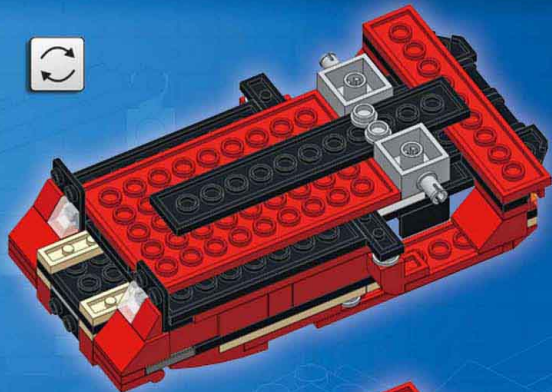
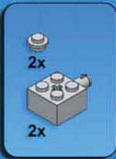

18

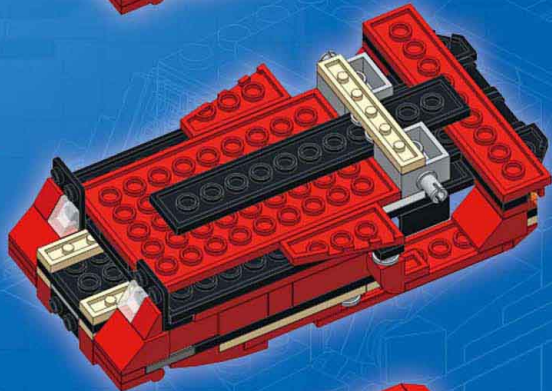
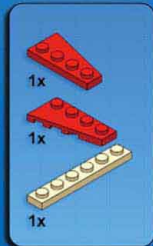

19

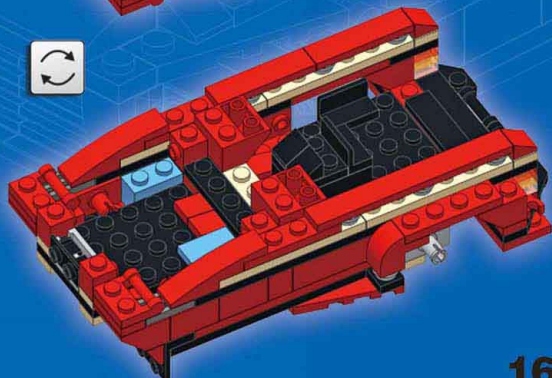



20

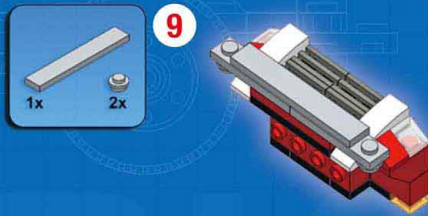
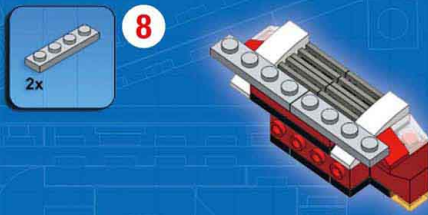
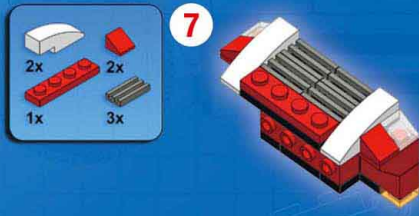
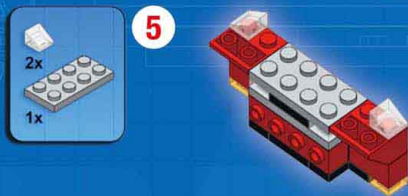
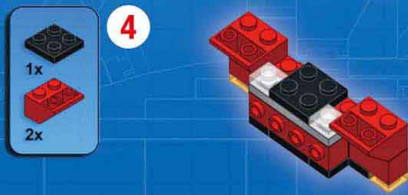
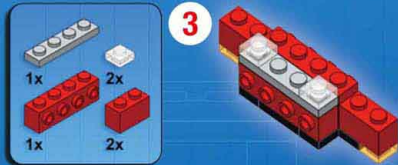

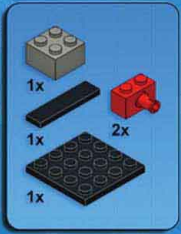

10

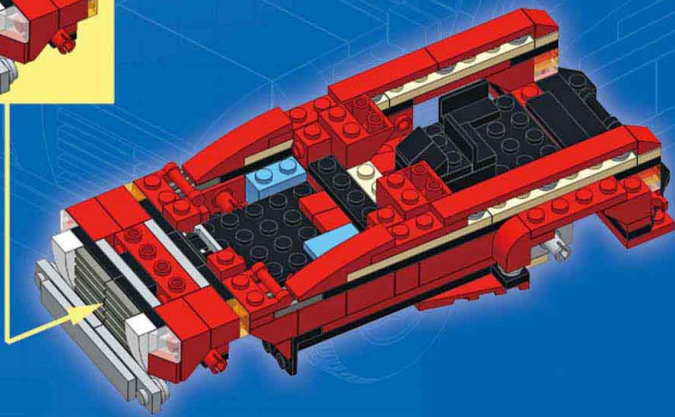
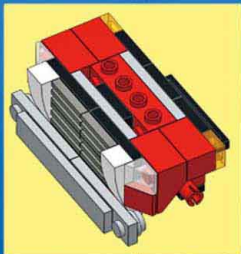
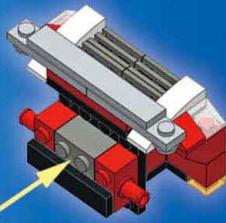
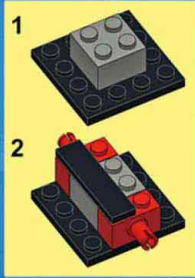

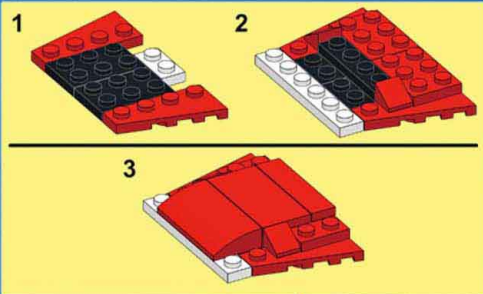

21

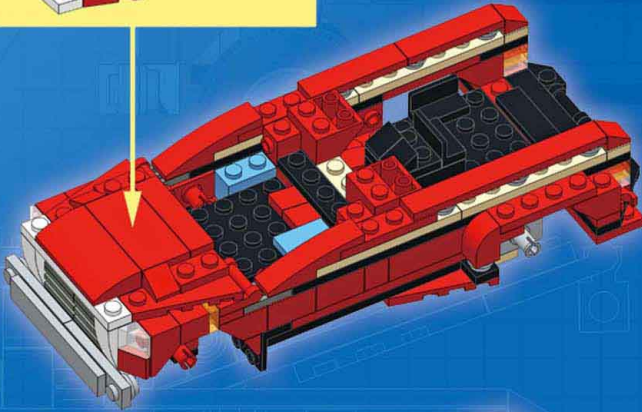
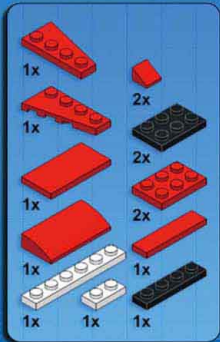

22

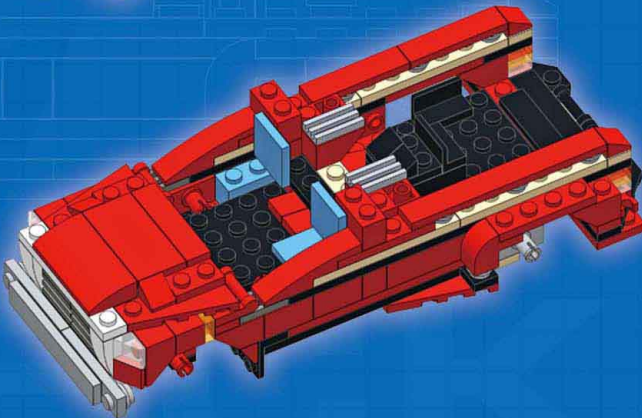
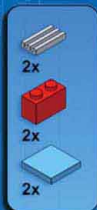

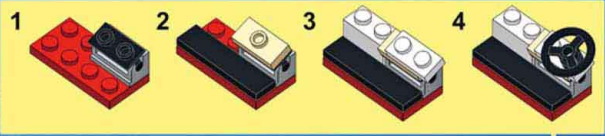

23

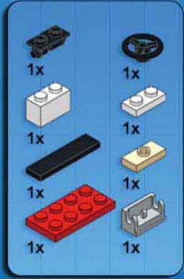
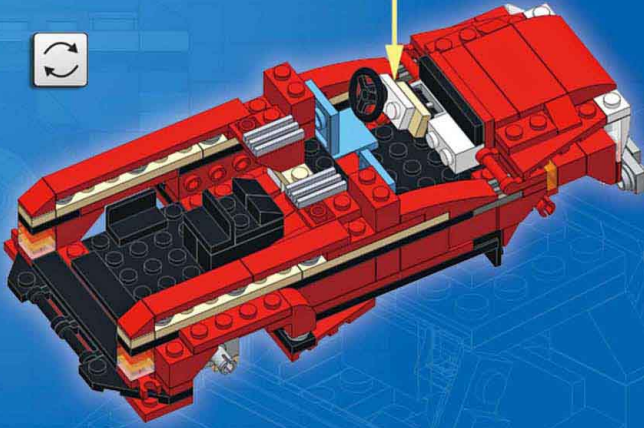

24

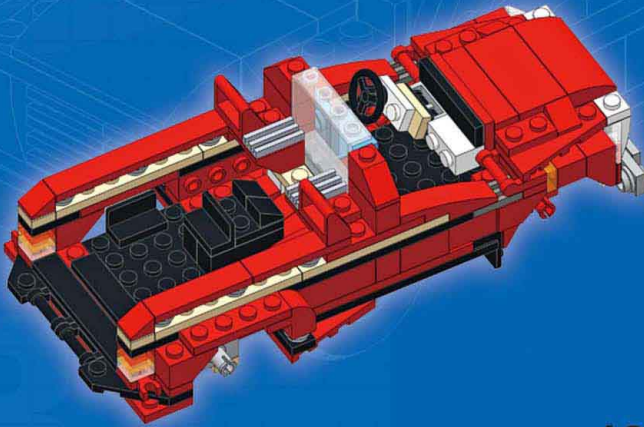
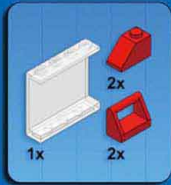



25

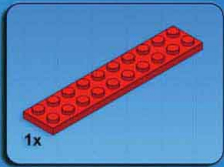

1

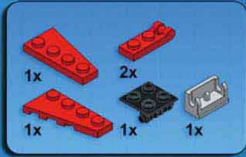
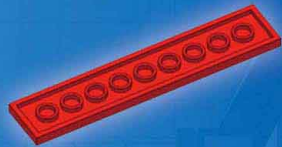

2

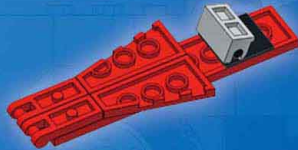

3

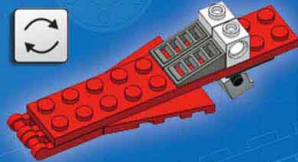

4

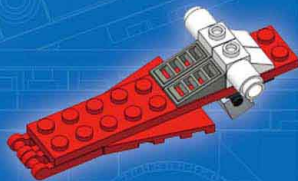

5

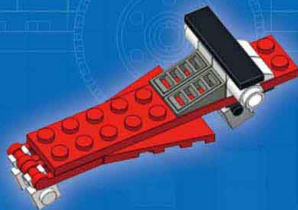

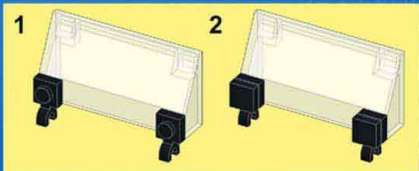
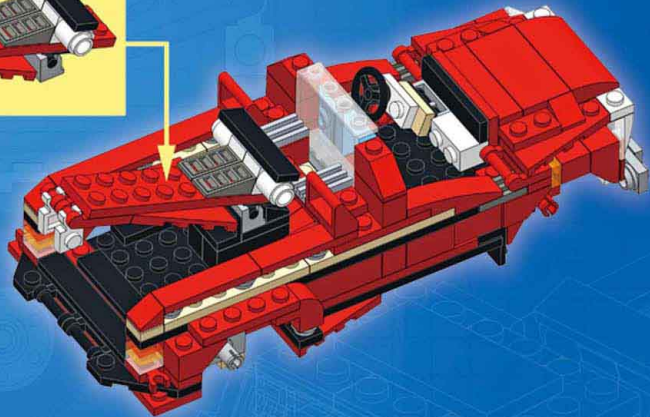
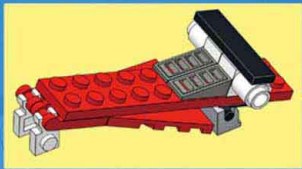

26

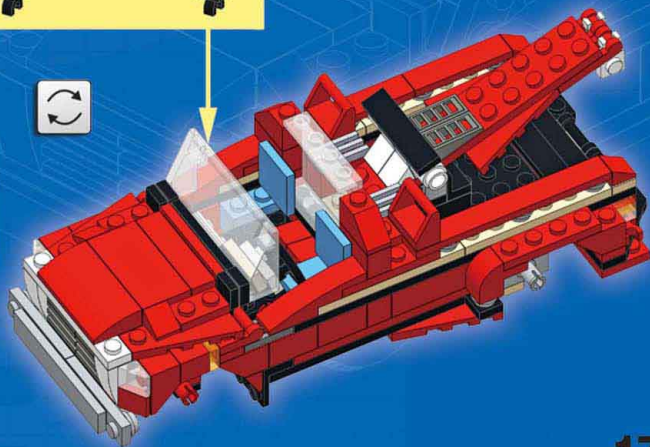

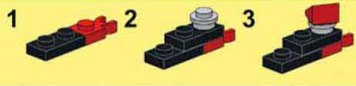

27

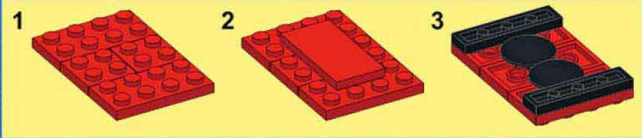
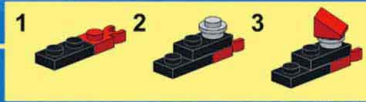
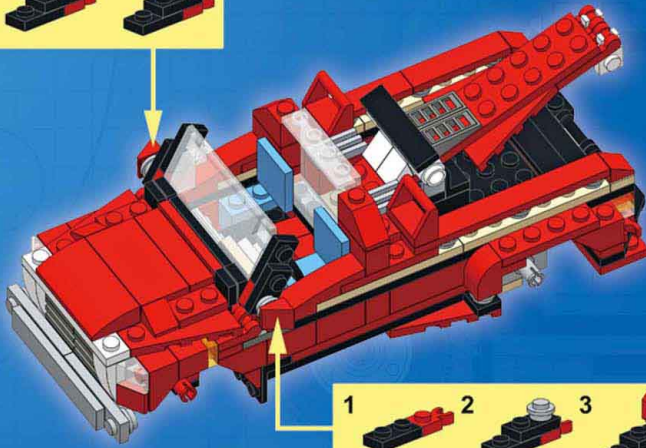

28

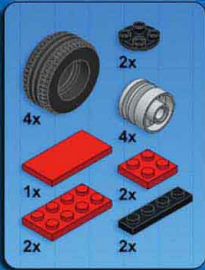



Complexity 
Functions 
Pieces 

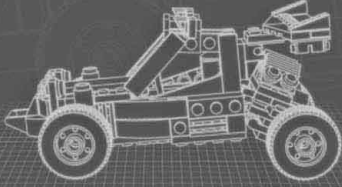
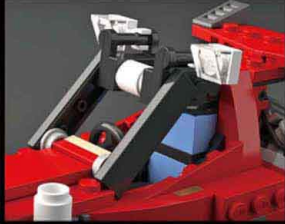

DUNE BUGGY

Design notes: roll cage, rear V4 engine, bull bar, exposed shocks, big rear wing, spotlights

Technical specifications:

Dimensions (l × w × h): 18 × 10 × 9 studs

Wheelbase: 12 studs

Axle width front/rear: 10/10 studs

Features: hinged rear axle

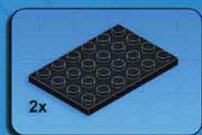

1



2

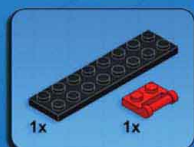
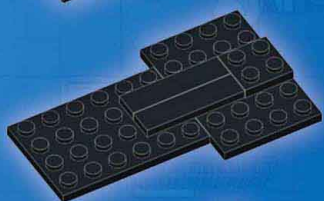

3

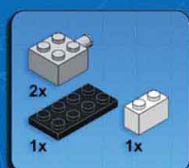

4

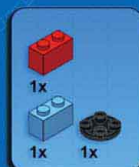
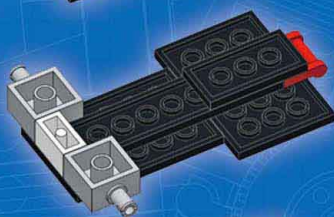

5

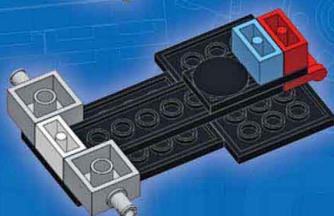



6

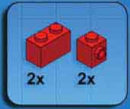
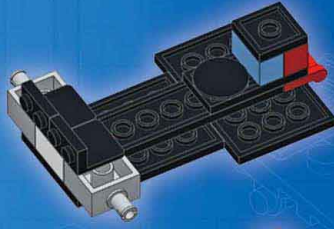

7

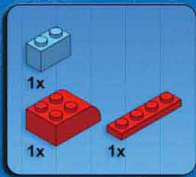
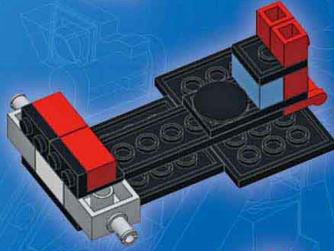

8

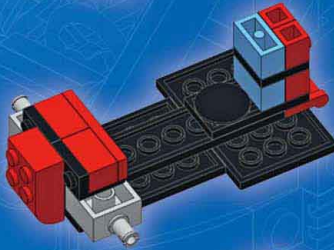

9

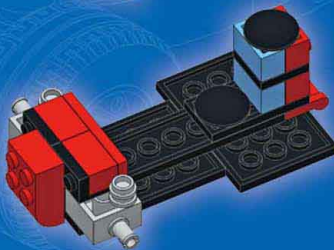



10

1

1x
1x

2

1x

3

1x
1x
1x

4

1x
1x
1x
1x

5

2x
1x

6

2x

7

1x
1x
1x
1x

8

1x
1x
1x
1x

9

1x
1x

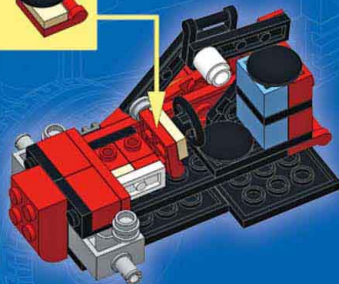
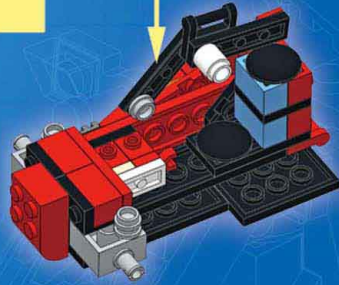
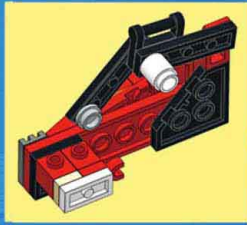

11

- 1x 
- 1x 
- 1x 
- 1x 



12

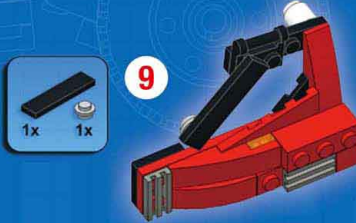
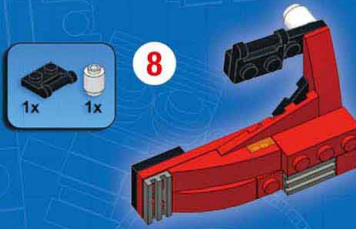
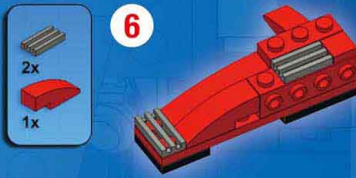
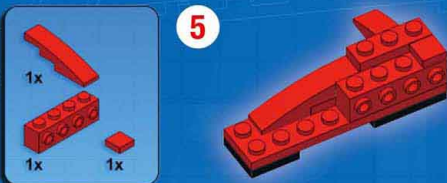
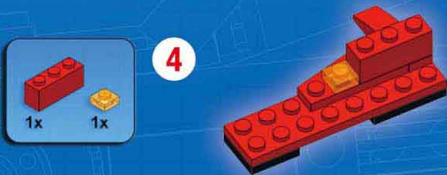
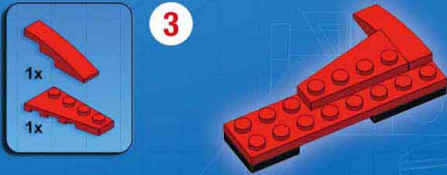
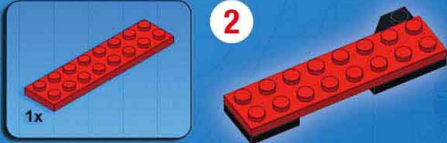

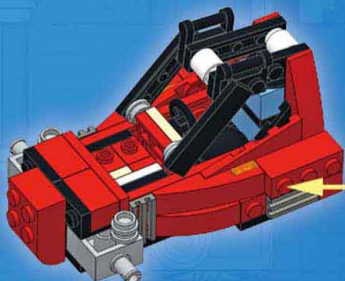

13

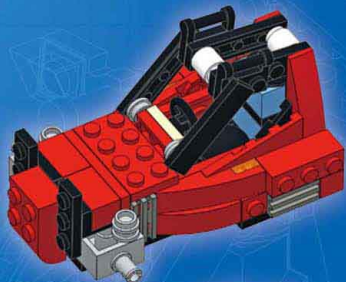
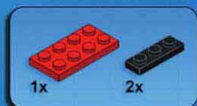

14

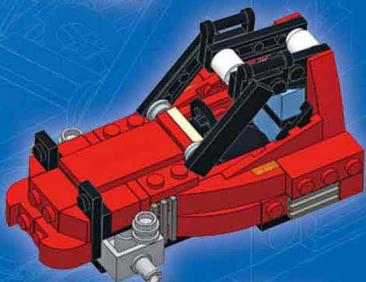
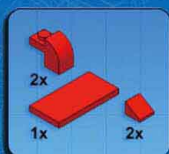

15





16



2x

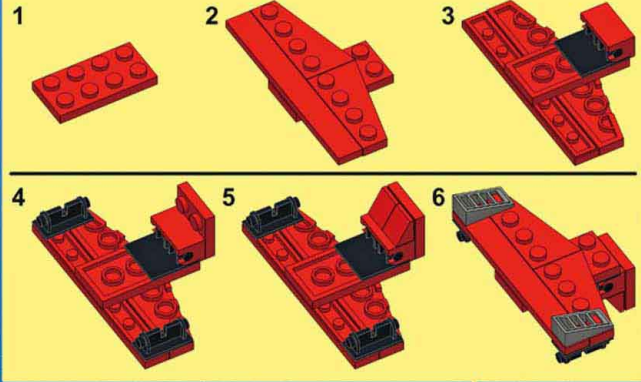
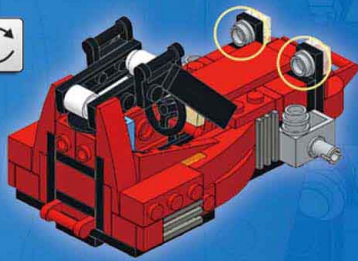

17

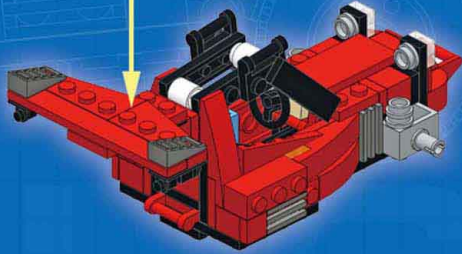
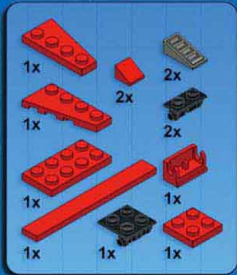



18



1



2

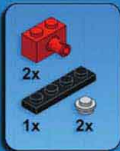

3

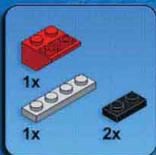
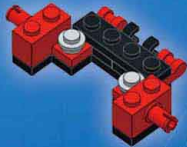

4

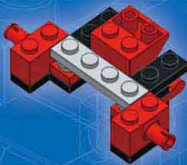

5



6

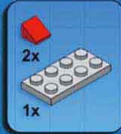

7



8



9





19

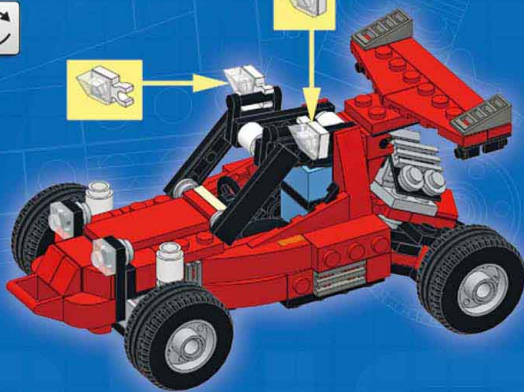



Complexity 
Functions 
Pieces 

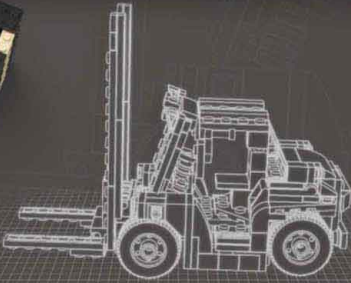
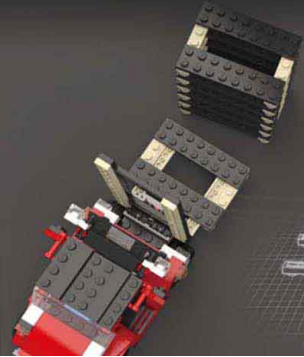
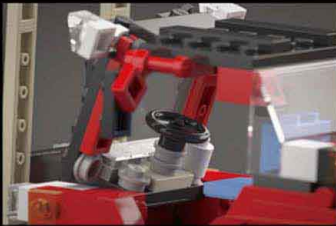

FORKLIFT

Design notes: short wheelbase, open cabin, big mirrors, spotlights

Technical specifications:
Dimensions (l x w x h): 22 x 10 x 16 studs
Wheelbase: 9 studs
Axle width front/rear: 8/8 studs

Features: tilting mast, folding fork, pallet



1

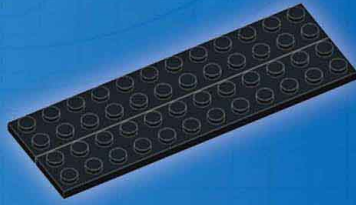
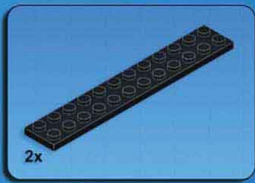

2

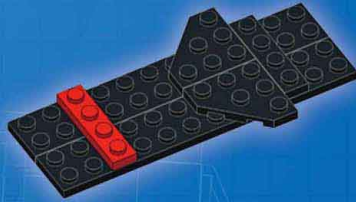
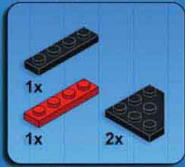

3

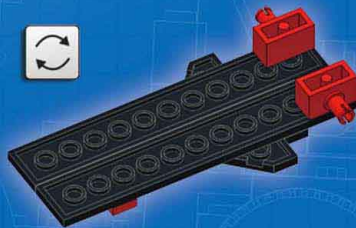

4

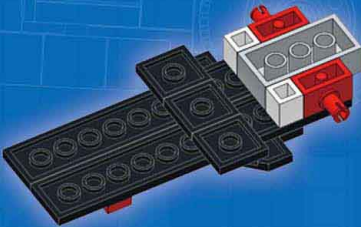
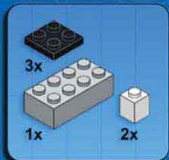



5

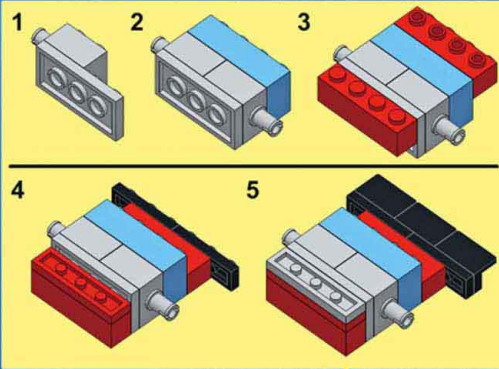
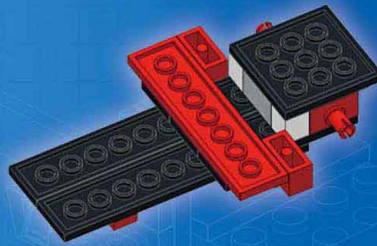
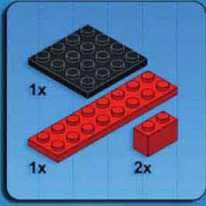

6

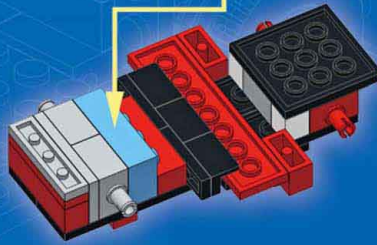
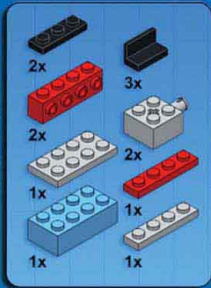

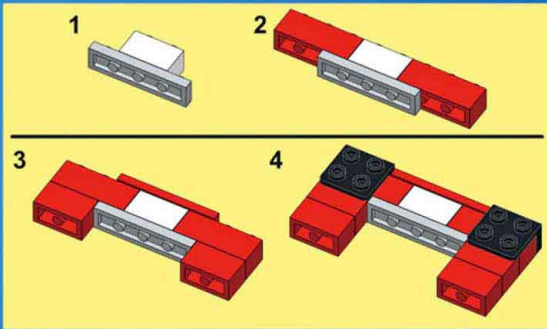

7

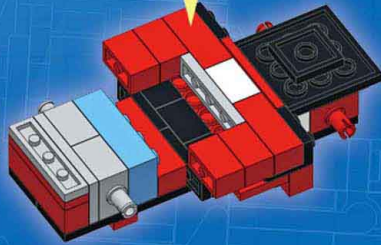
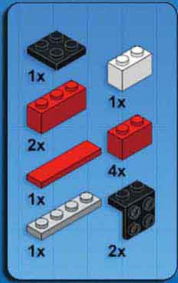

8

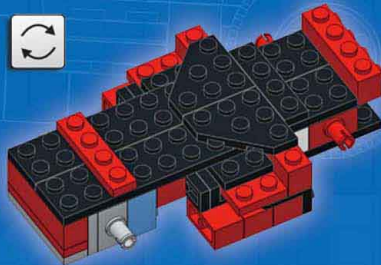
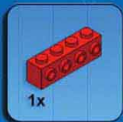

9

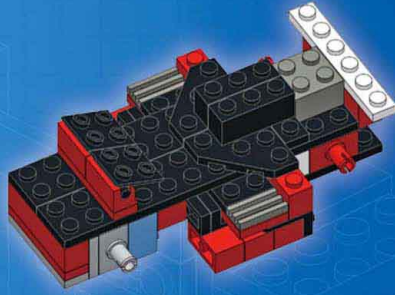
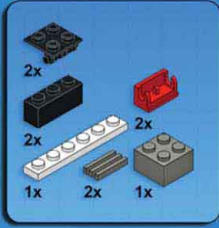

10

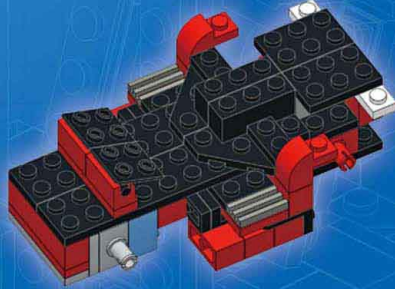

11

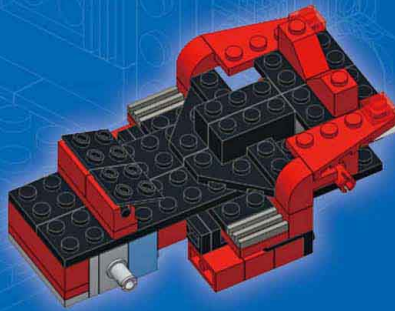
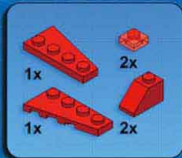



12

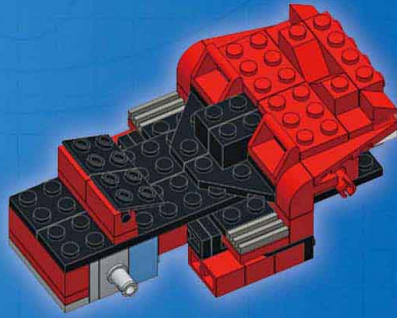
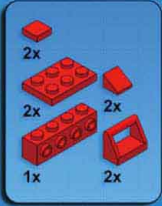

13

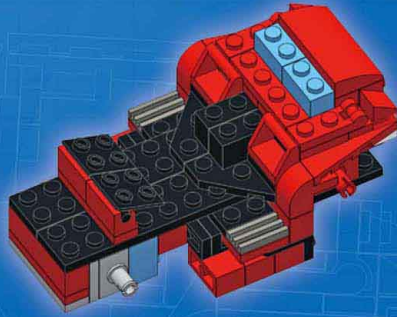
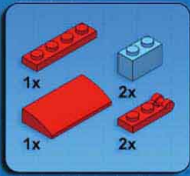

14

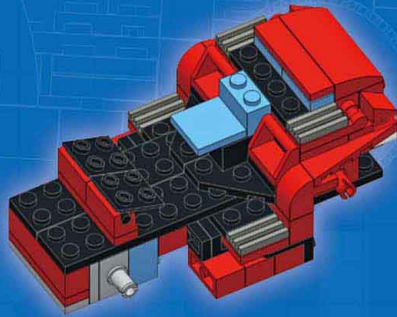
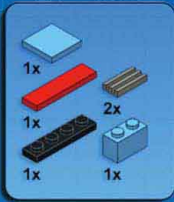



15

- 1x
- 1x
- 1x
- 1x
- 1x
- 1x
- 1x
- 1x
- 1x
- 1x
- 1x
- 1x
- 1x
- 1x

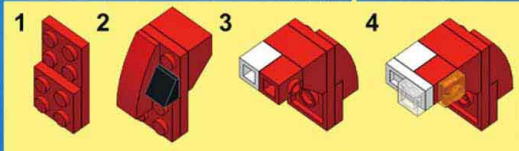
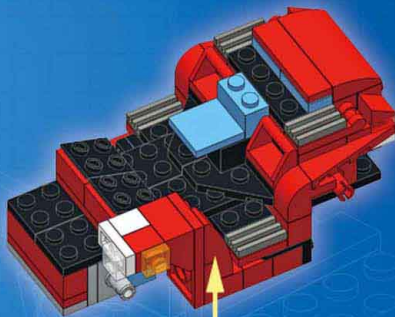

16

- 1x
- 1x
- 1x
- 1x
- 1x
- 1x
- 1x
- 1x
- 1x
- 1x
- 1x
- 1x
- 1x
- 1x

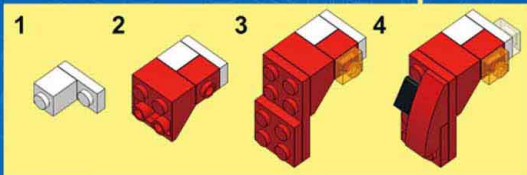
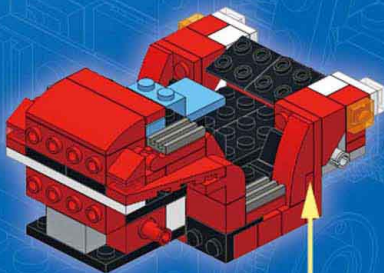



17

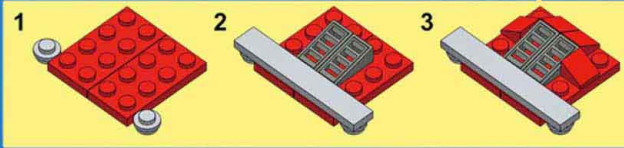
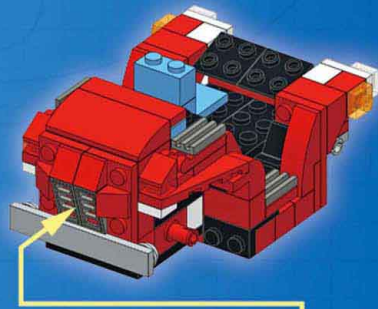
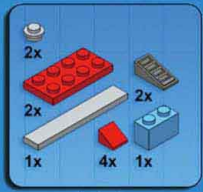

18

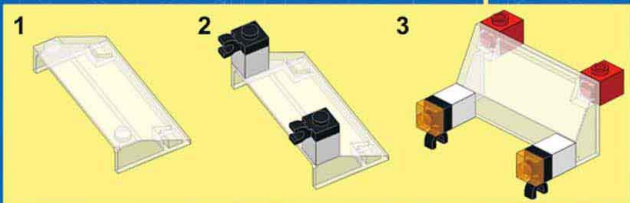
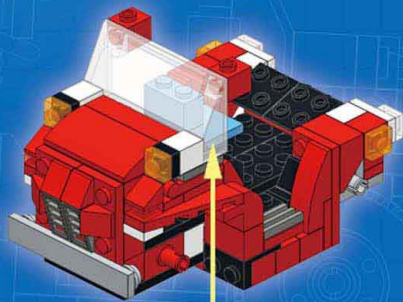
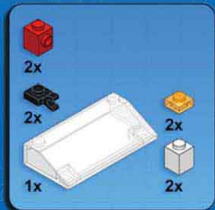

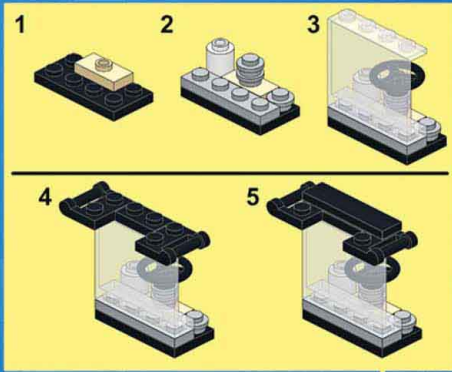

19

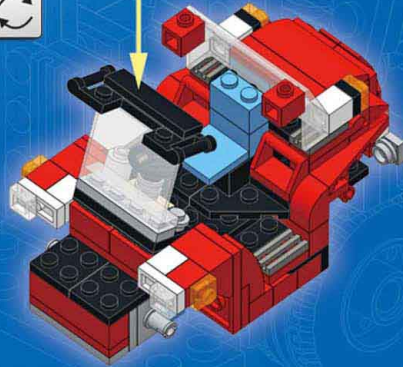
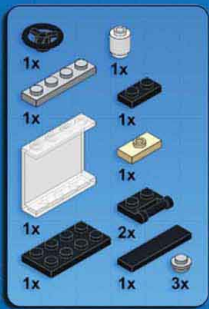



20

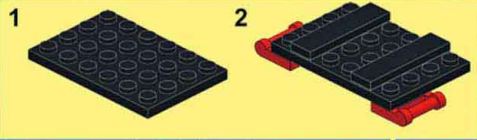
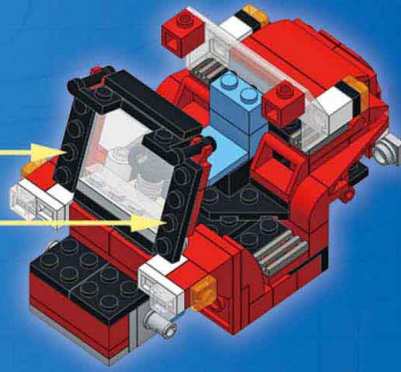
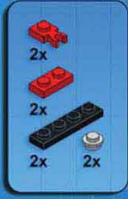

21

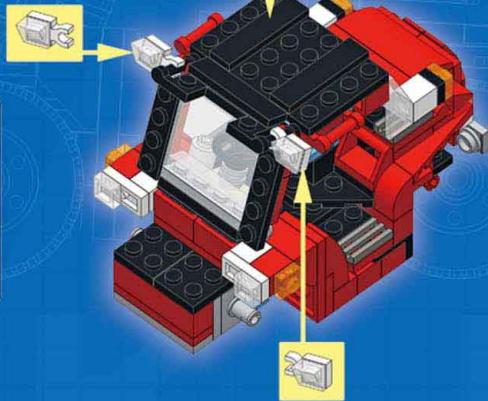



22



1

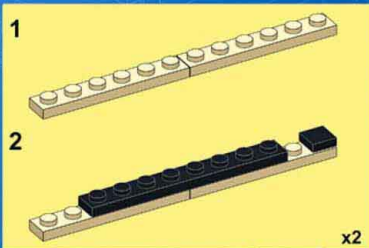

2

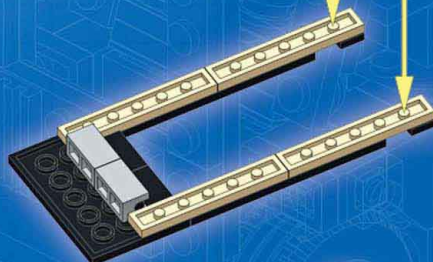
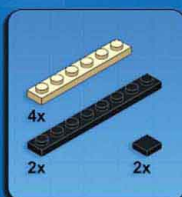

3

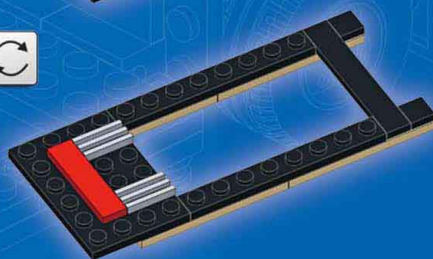

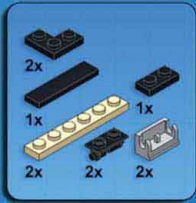

4

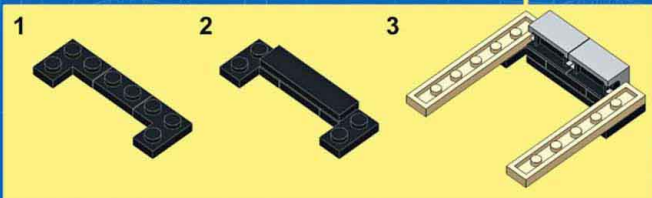
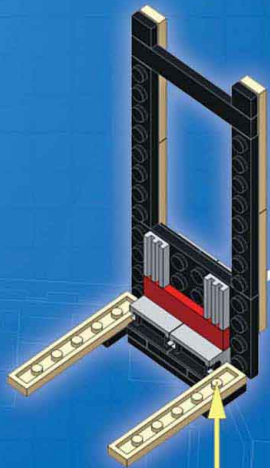

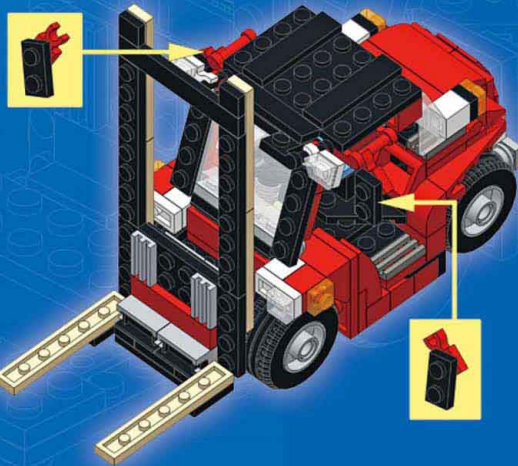
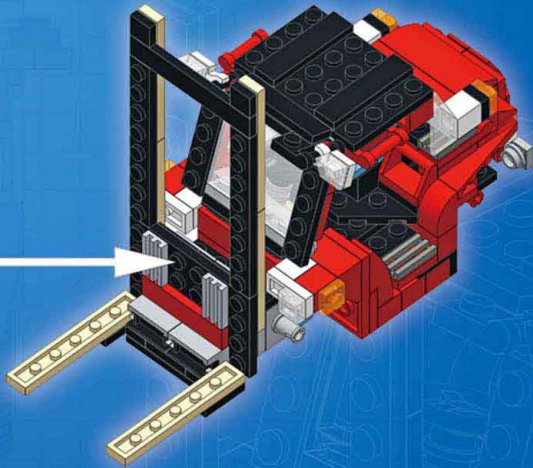

23





24

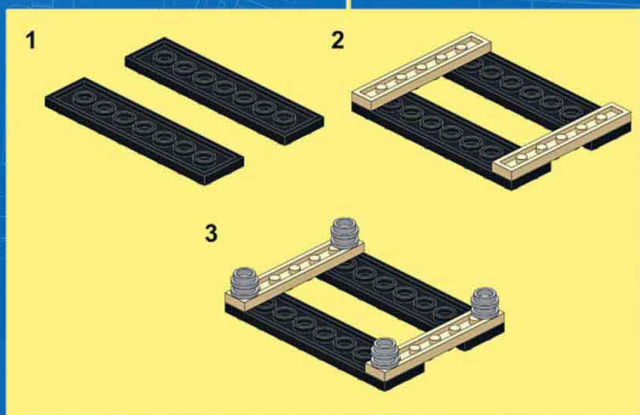
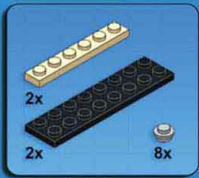



Complexity 
Functions 
Pieces 

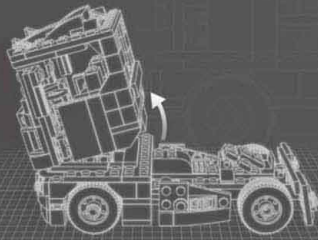

BIG RIG

Design notes: spacious cabin, big mirrors, massive grille, airfoil, fifth wheel, mudguards

Technical specifications:

Dimensions (l x w x h): 20 x 14 x 14 studs

Wheelbase: 12 studs

Axle width front/rear: 10/10 studs

Features: opening doors, tipping cabin



1

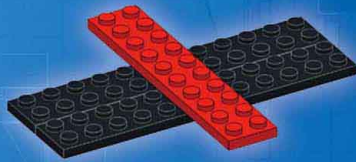
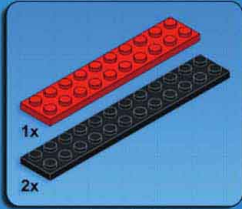

2

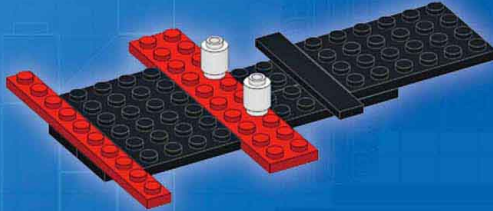

3

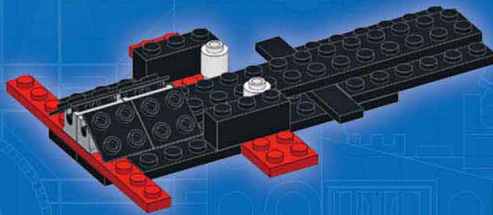
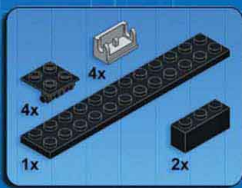

4

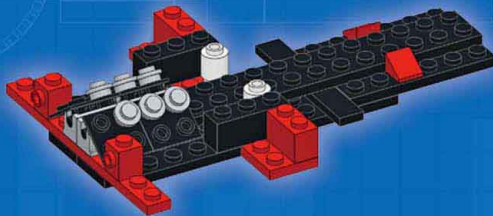



5

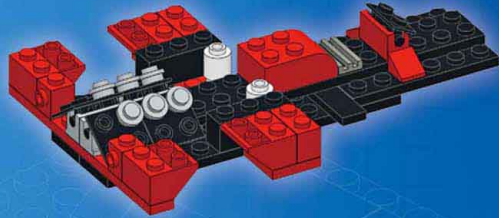
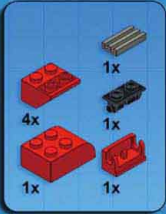

6

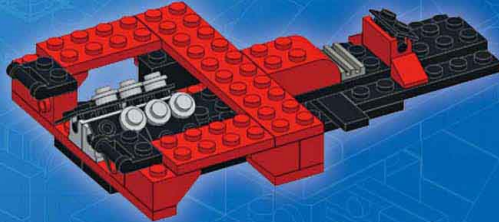
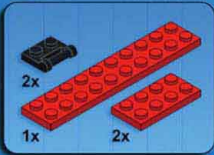

7

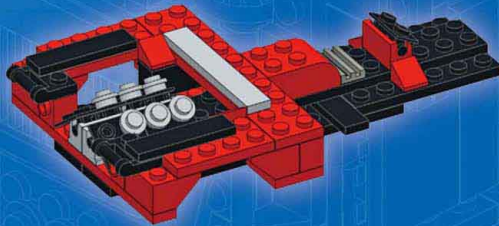
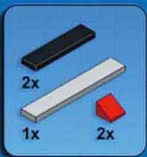

8

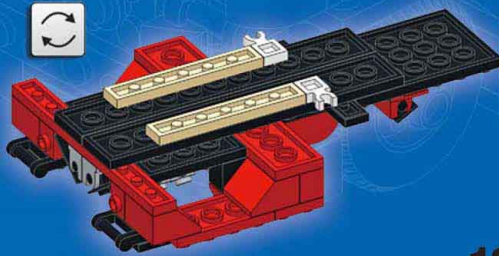



9

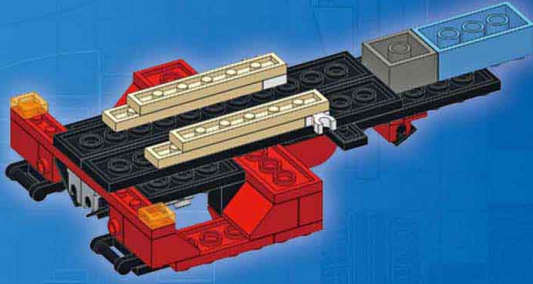
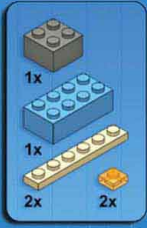

10

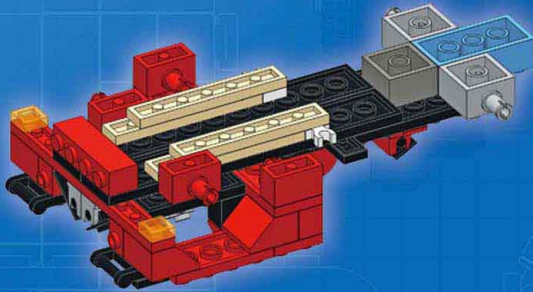
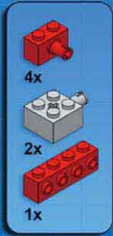

11

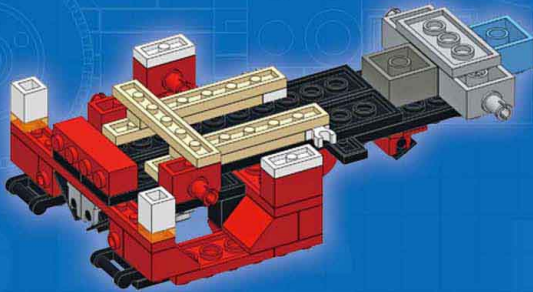
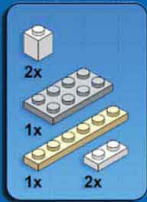



12



- 2x
- 2x
- 3x
- 2x
- 2x
- 2x
- 1x
- 1x
- 1x
- 2x
- 2x
- 1x

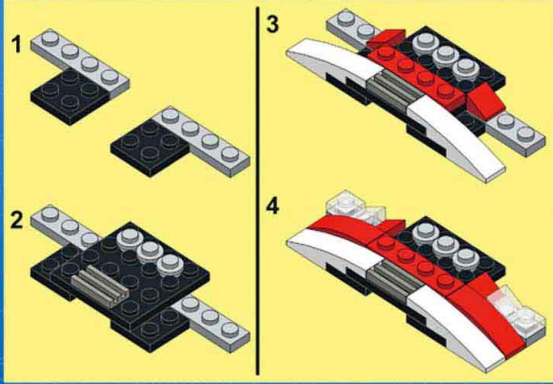
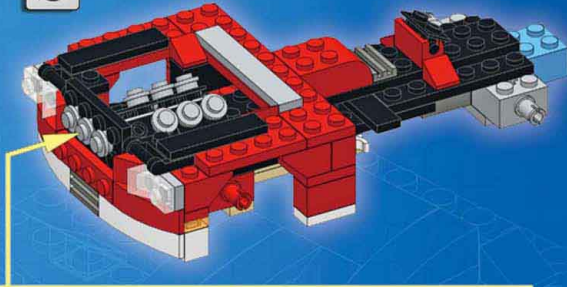

13

- 1x
- 1x
- 3x

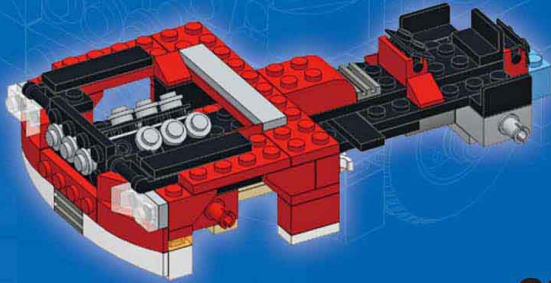



14

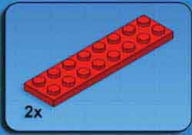

1

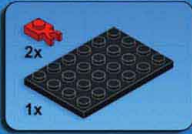
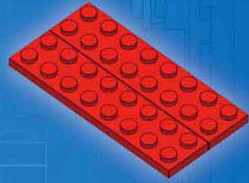

2

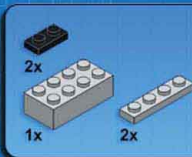
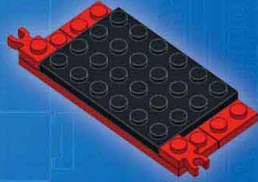

3

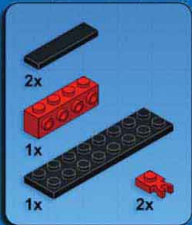
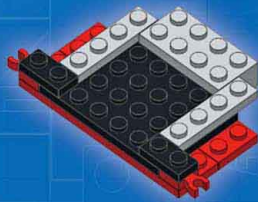

4

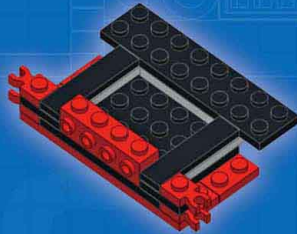

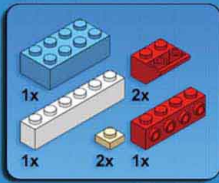

5

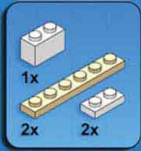
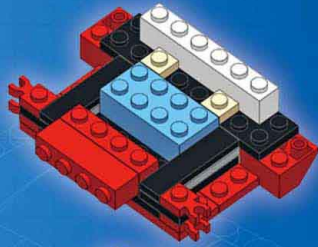

6

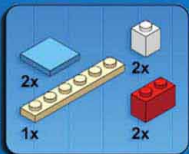
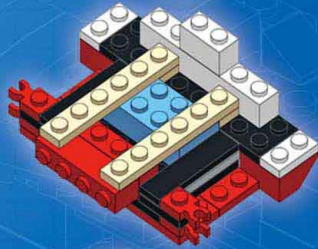

7

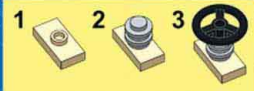
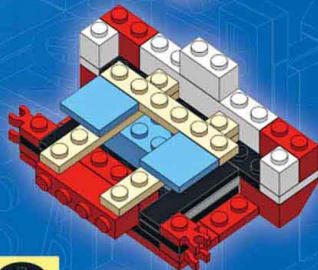

8

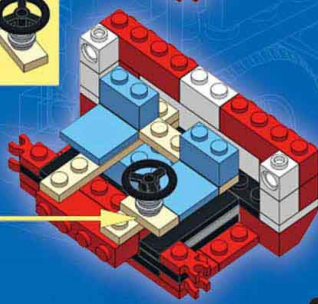
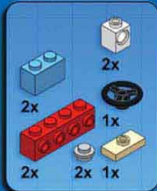

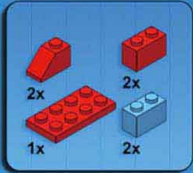

9

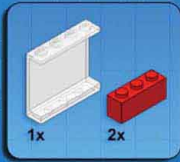
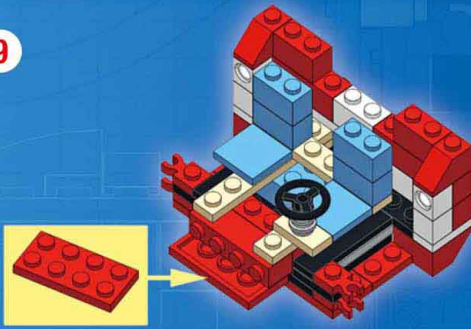

10

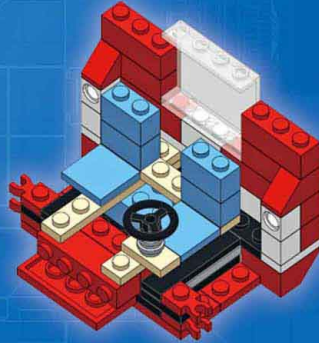

11

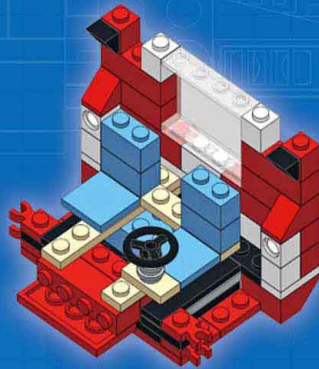



15

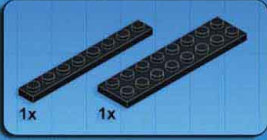

1

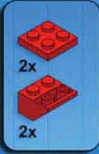

2

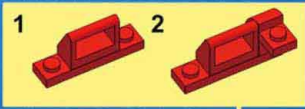
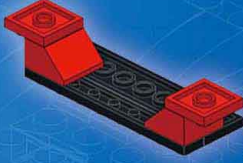

3

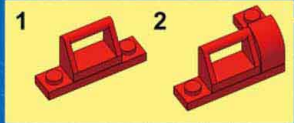
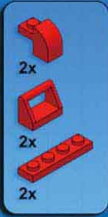
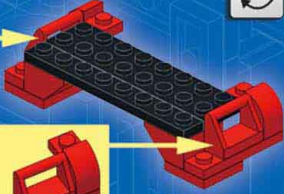

4

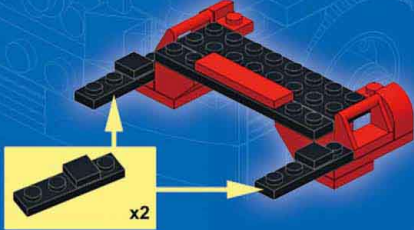
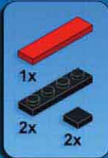

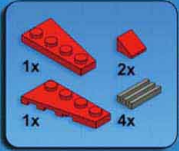

5

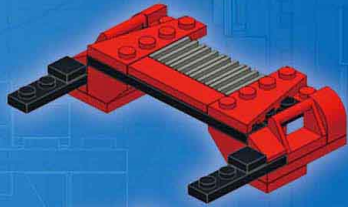

6

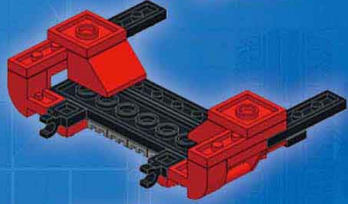

7

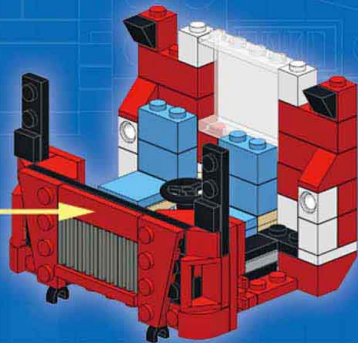
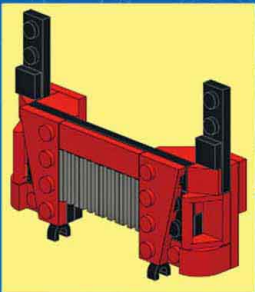
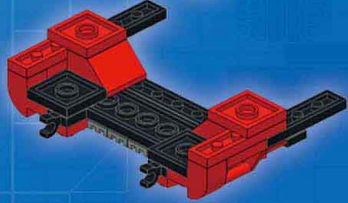



16

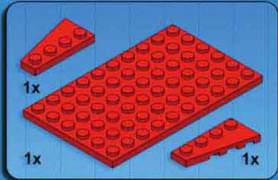

1

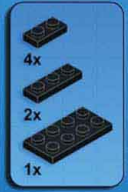
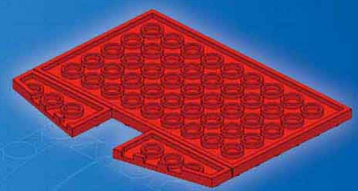

2

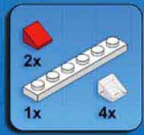

3

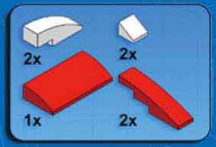
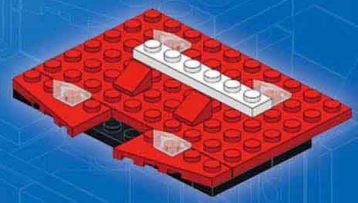

4

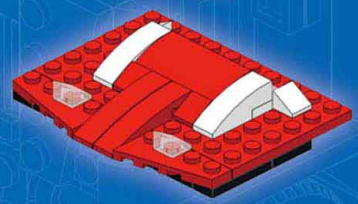

5

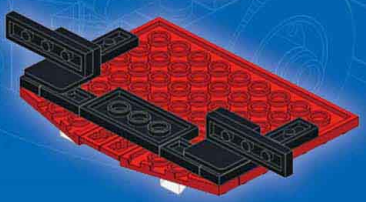

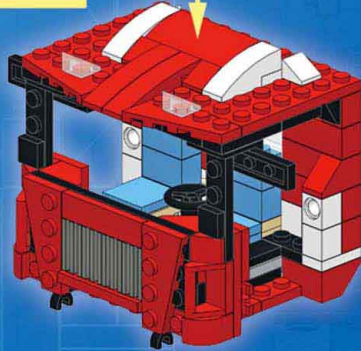
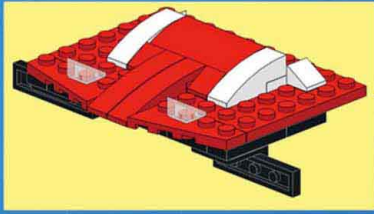

x2

17



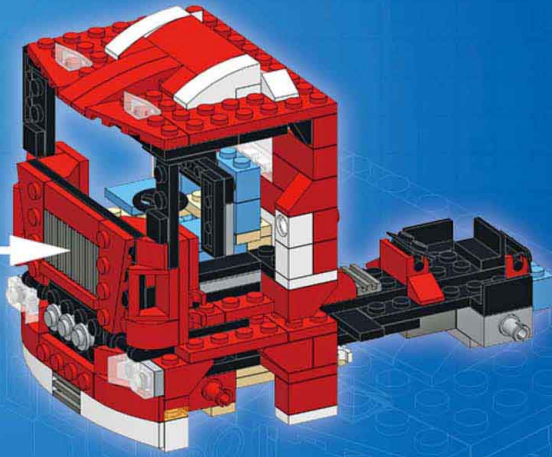

18

- 1x
- 1x
- 1x
- 1x
- 1x

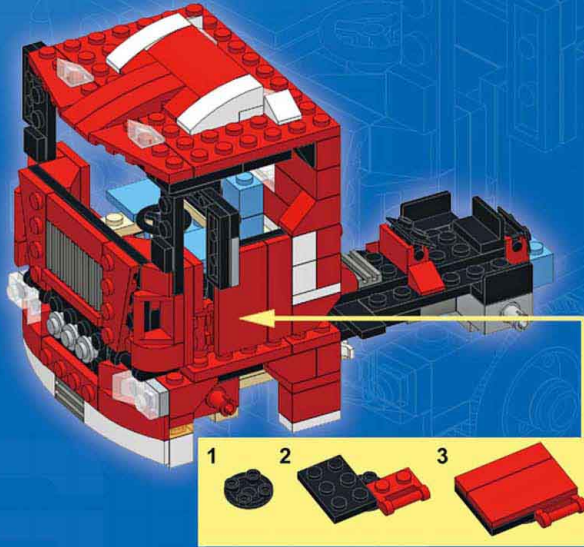



19

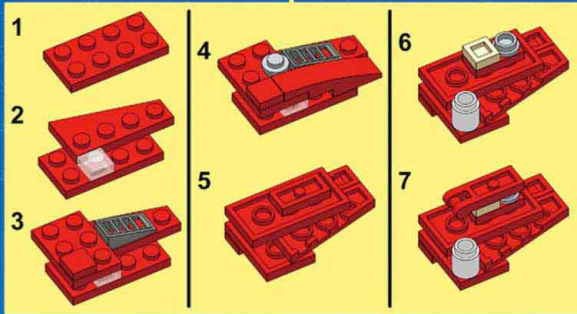
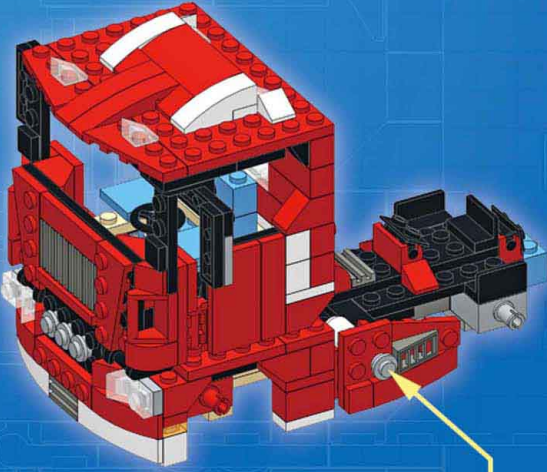
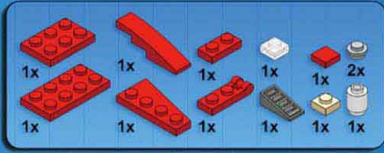



21

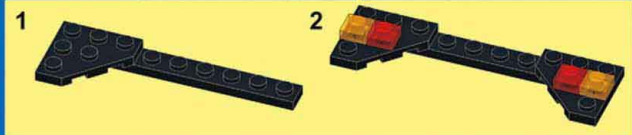
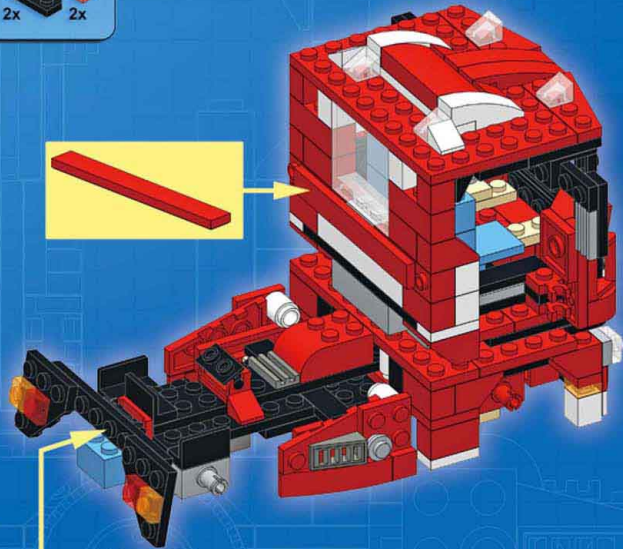
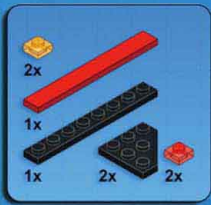

22

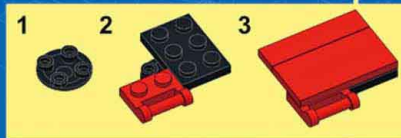
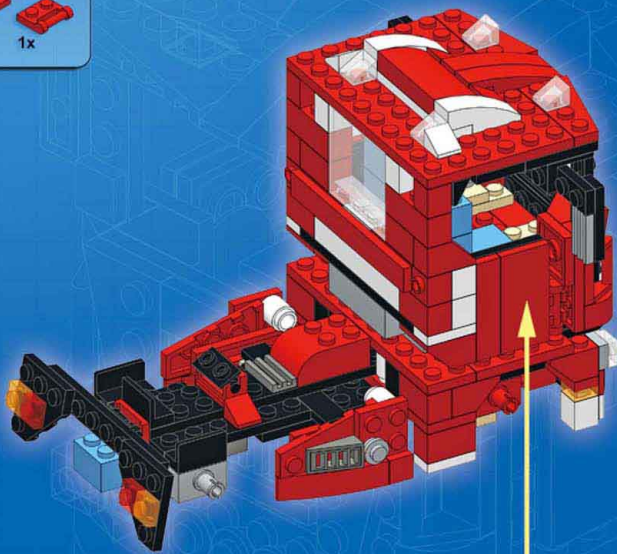
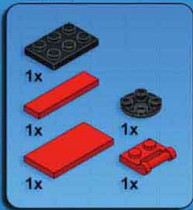



23

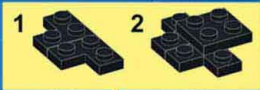



Complexity 
Functions 
Pieces 

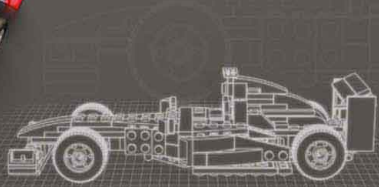
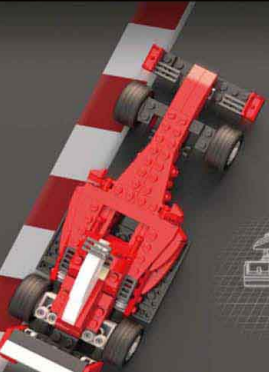

F1 RACER

Design notes: low chassis, aerodynamic shape, open-wheeled design, air intakes, front and rear wings

Technical specifications:
Dimensions (l × w × h): 27 × 10 × 8 studs
Wheelbase: 17 studs
Axle width front/rear: 10/10 studs



1

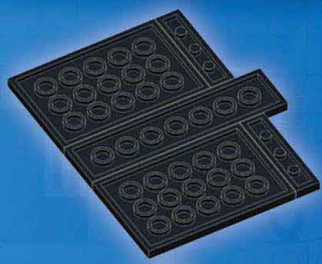
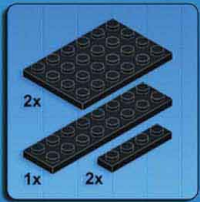

2

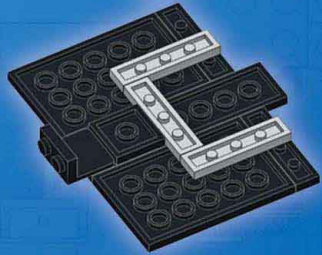
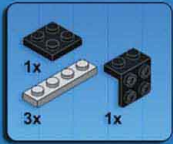

3

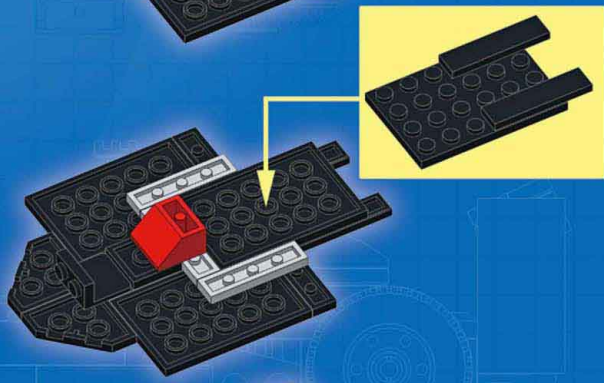
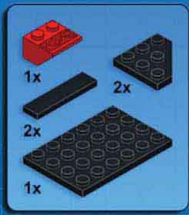

4

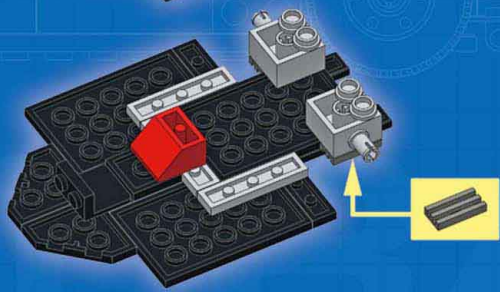
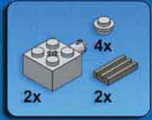



5

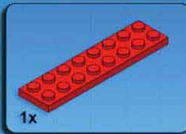

1

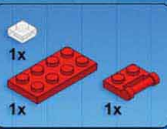
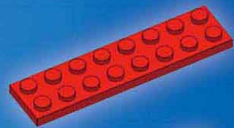

2

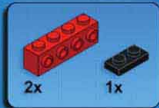
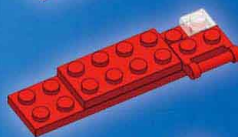

3

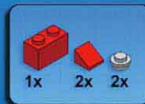
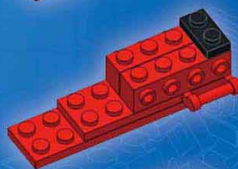

4

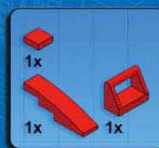
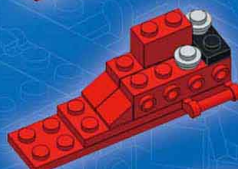

5

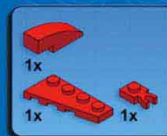
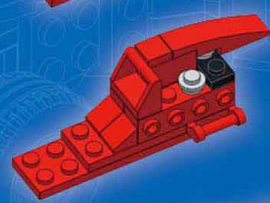

6

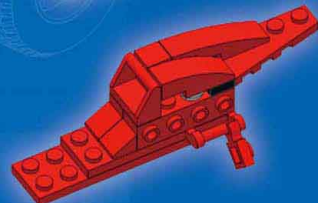

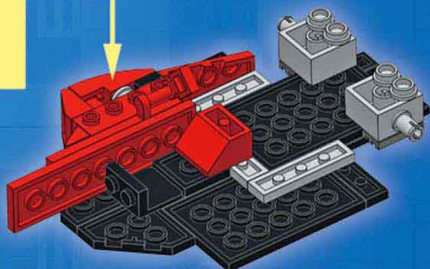
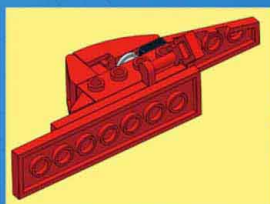

6

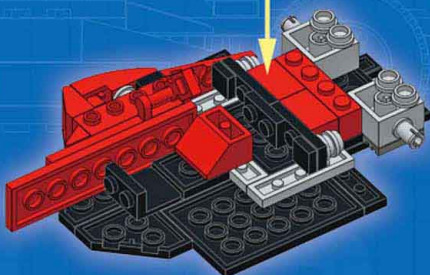
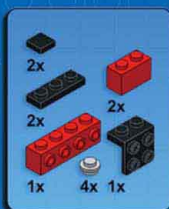



7

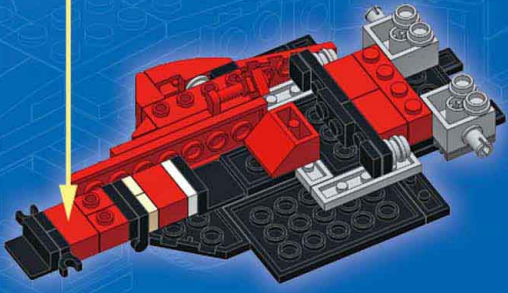
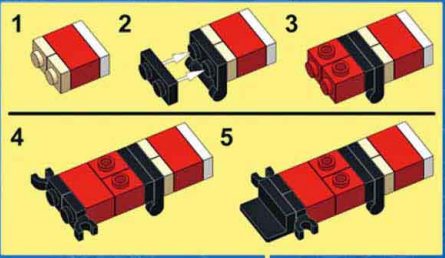
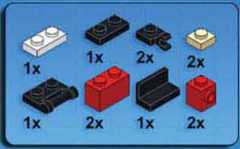



8

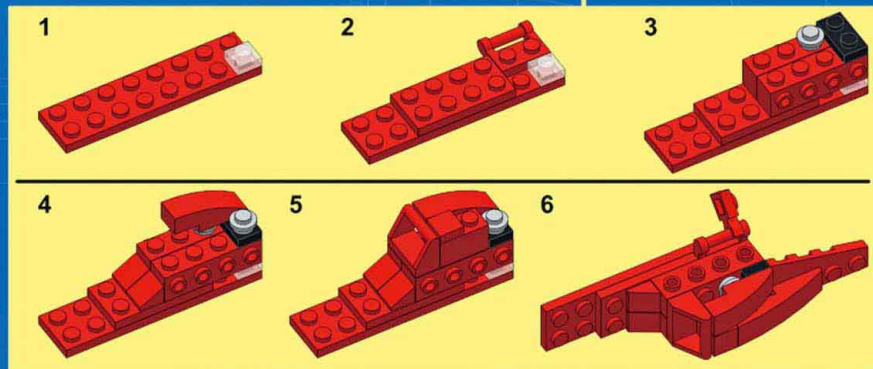
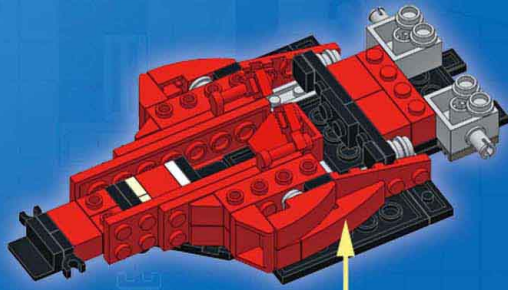
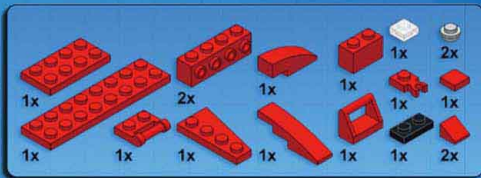



9

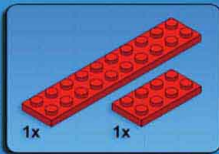

1

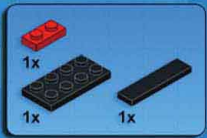
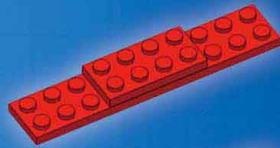

2

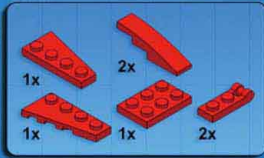
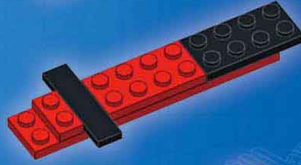

3

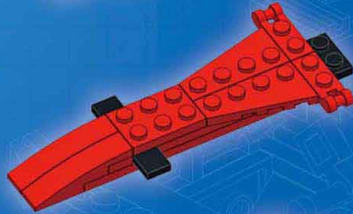

4

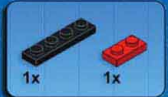
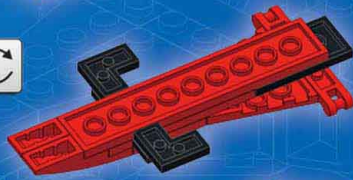

5

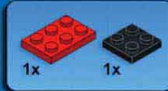

6

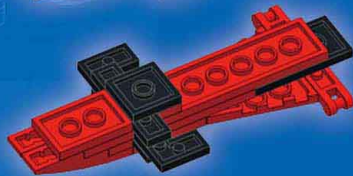

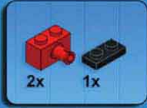
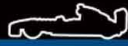

7

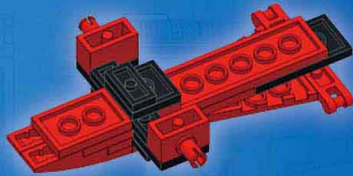

8

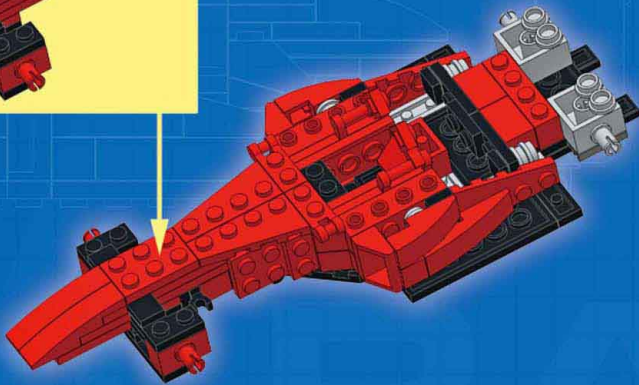
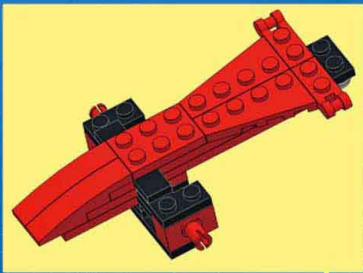
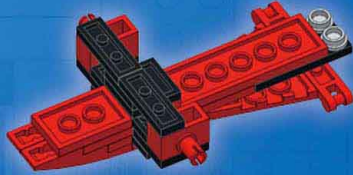



10

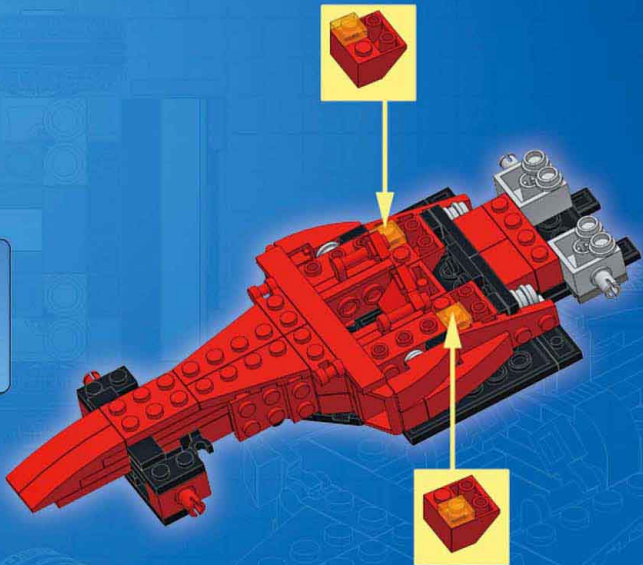
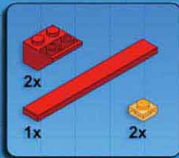

11

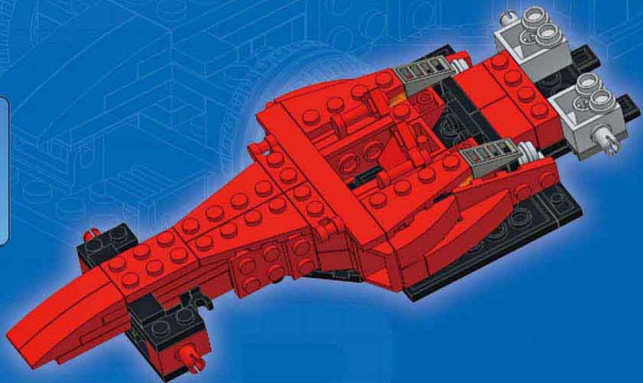
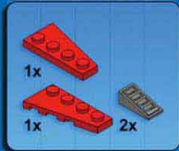



12

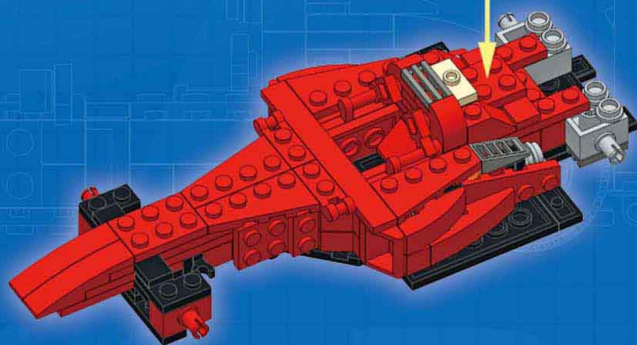
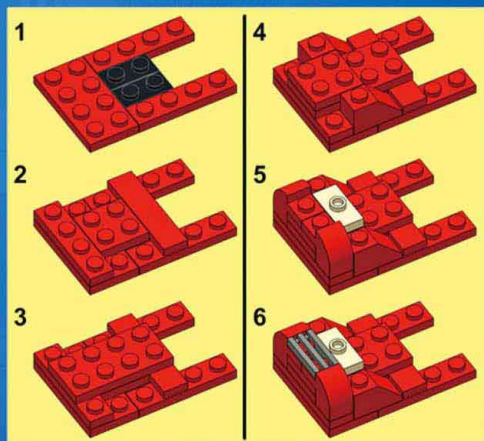
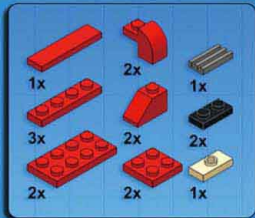



13

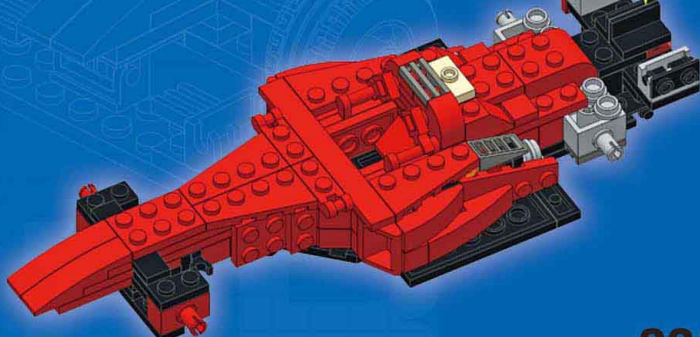
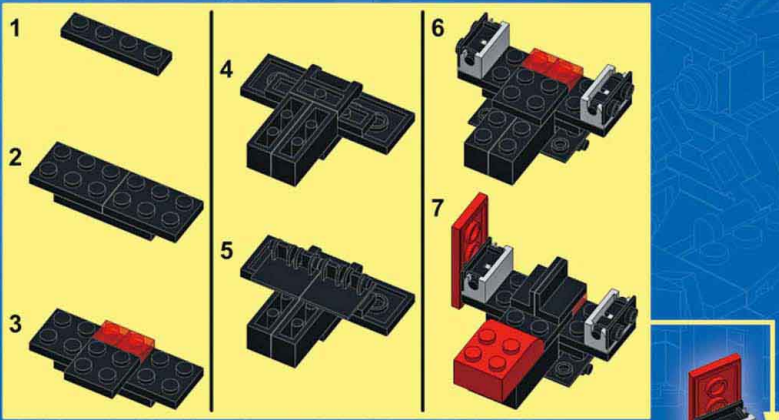
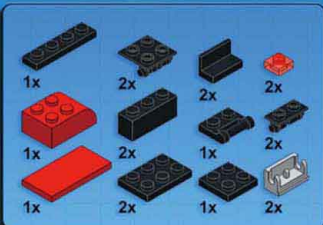



14

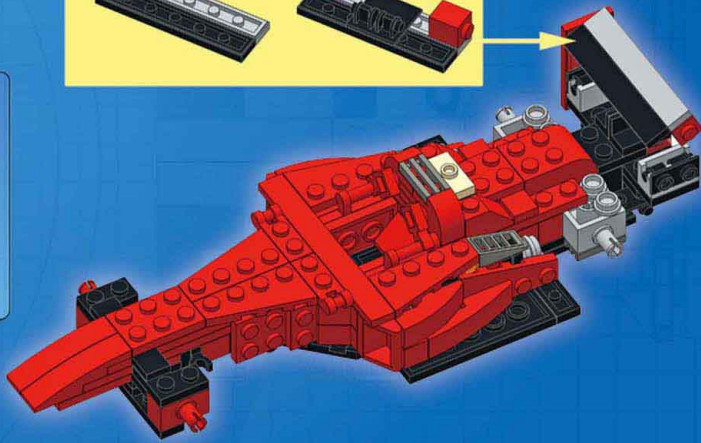
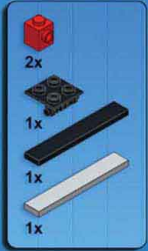
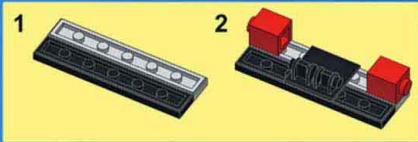

15

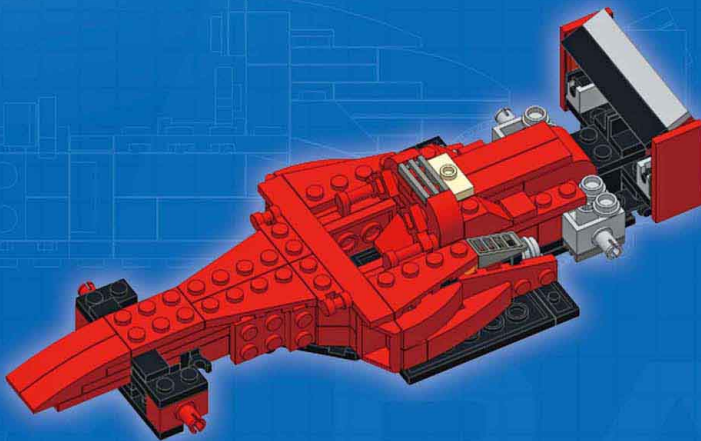
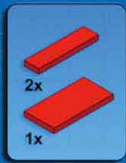



16

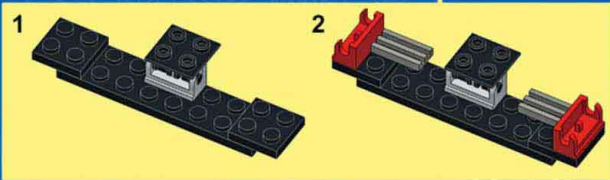
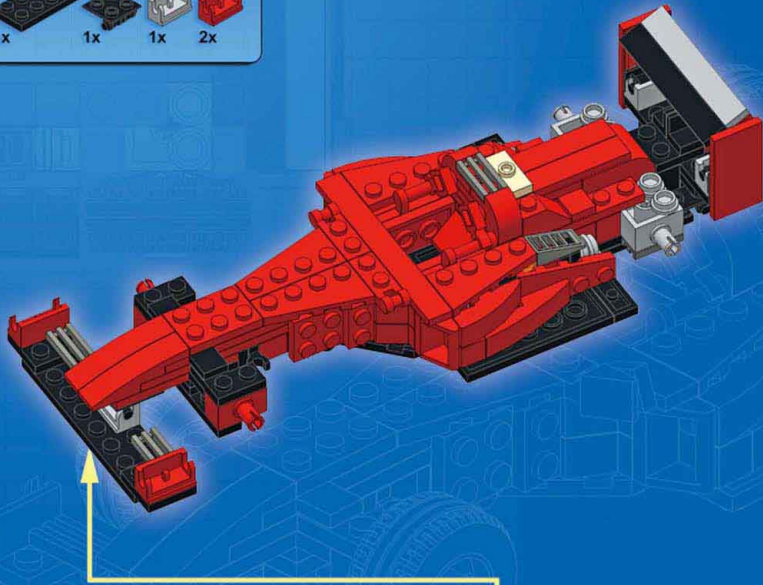
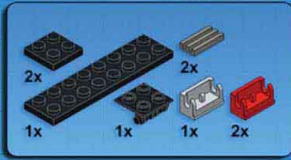

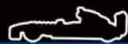

17

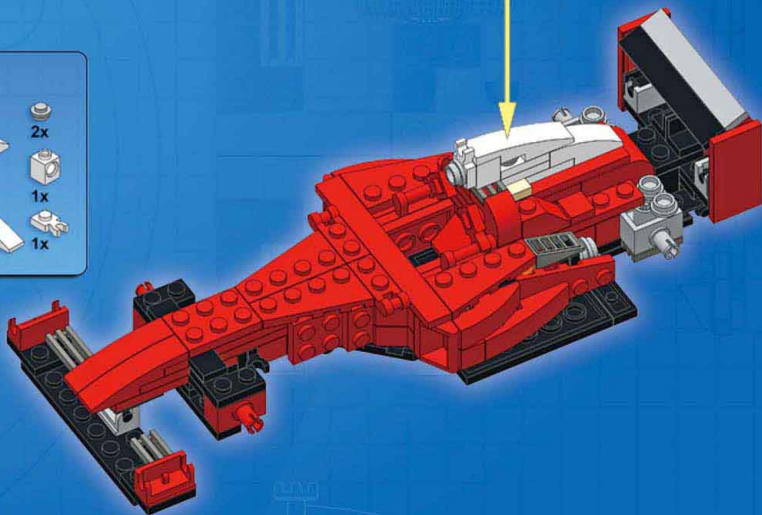
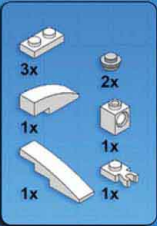

18

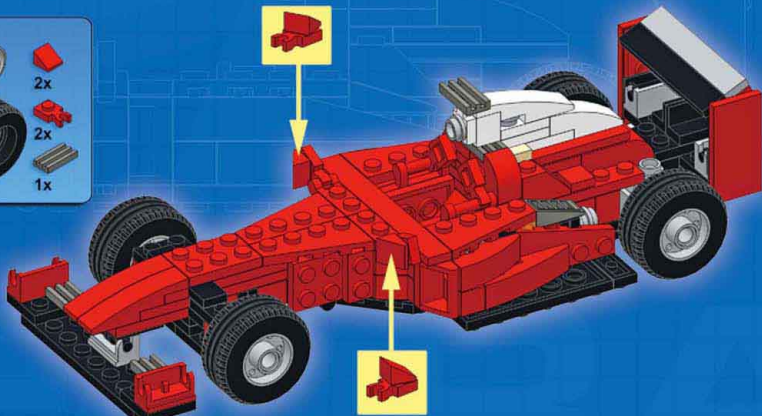



Complexity 
Functions 
Pieces 

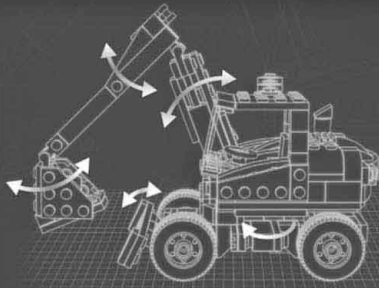

EXCAVATOR

Design notes: short wheelbase, high clearance, offset cabin, vertical exhaust, hazard light

Technical specifications:

Dimensions (l x w x h): 17 x 9 x 16 studs

Wheelbase: 9 studs

Axle width front/rear: 8/8 studs

Features: rotating turret; front blade; articulated arm, dipper, and bucket



1

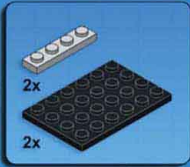

2

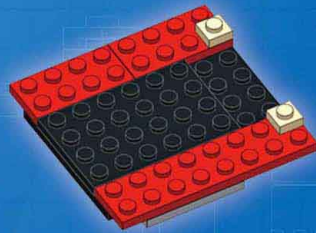
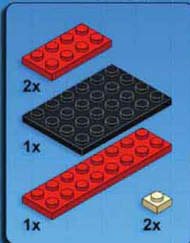

3

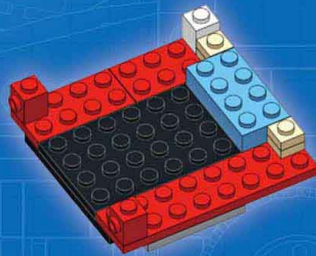
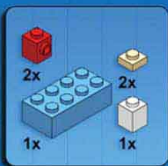

4

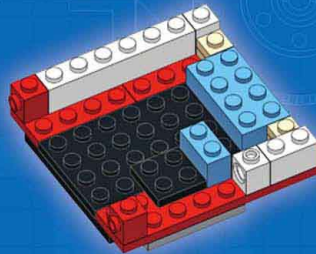
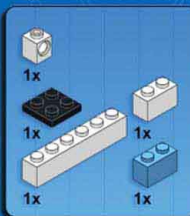

5

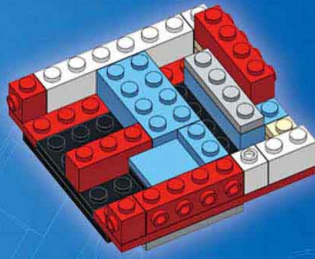
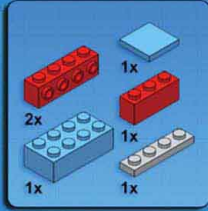

6

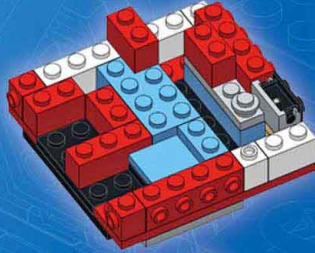

7

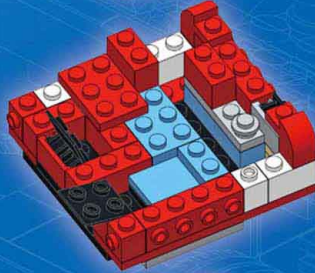

8

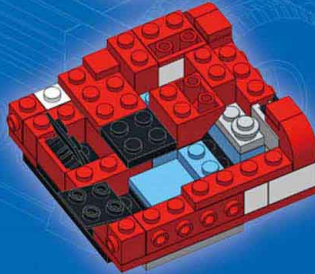
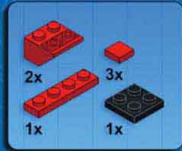



9

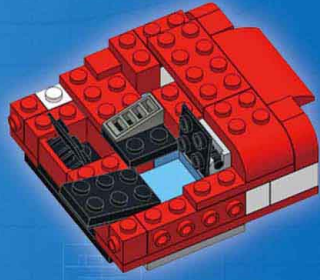
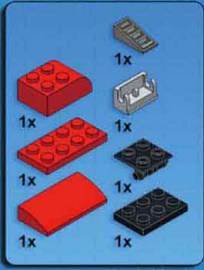

10

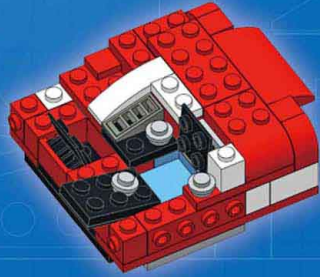
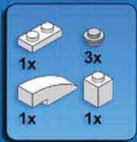

11

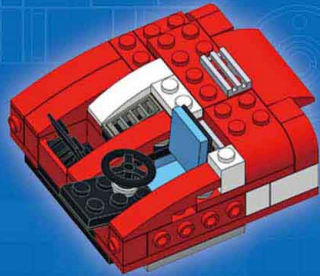
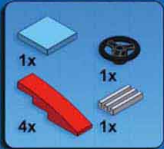

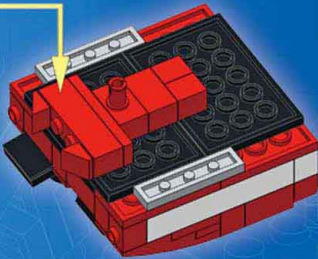
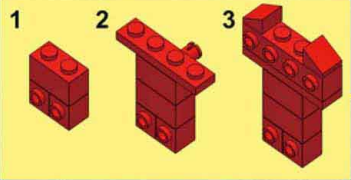

12

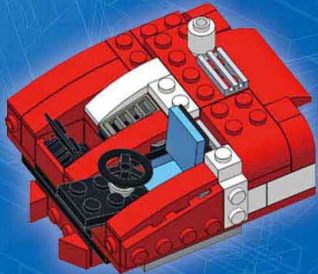
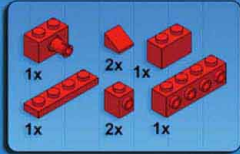

13

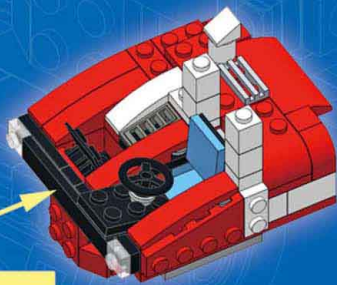
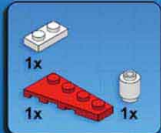

14

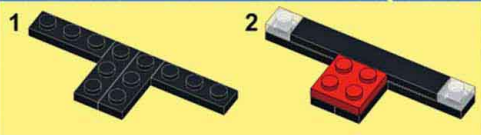
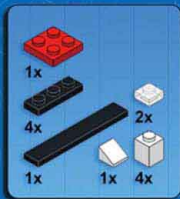



15

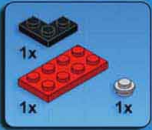

1

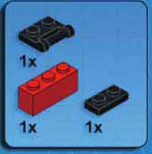

2

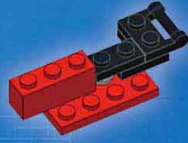

3

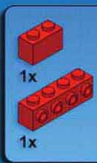
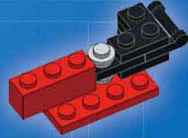

4

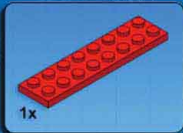
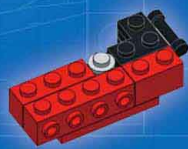

5

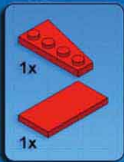
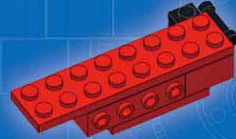

6

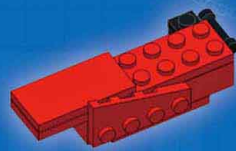

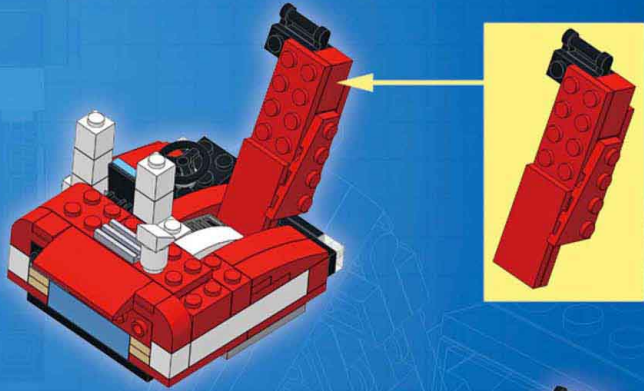

16

- 1x
- 2x
- 2x
- 2x
- 1x
- 2x

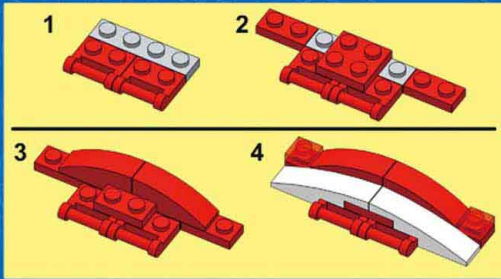
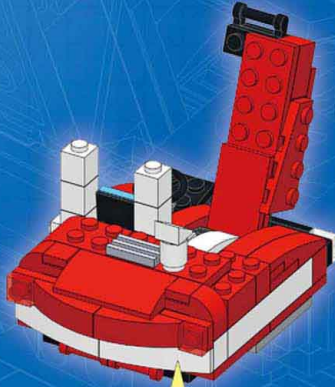



17



1



2

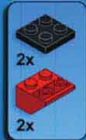

3

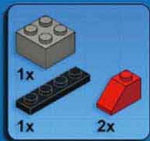
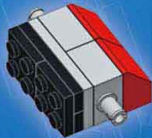

4

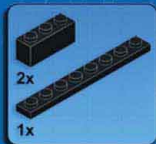

5



6

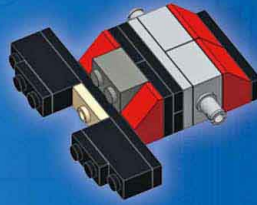

7

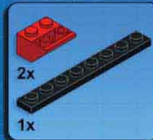

8

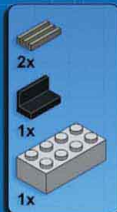
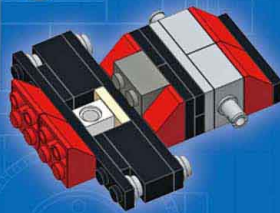

9

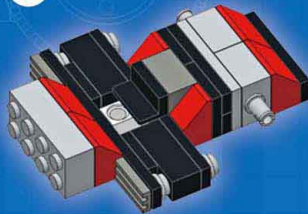

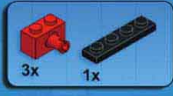

10

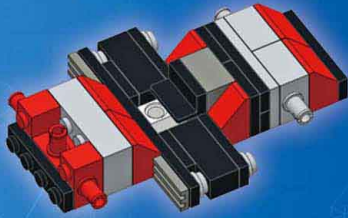

11

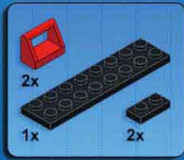
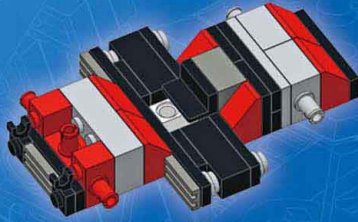

12

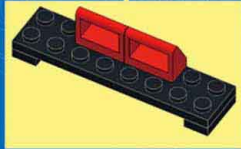
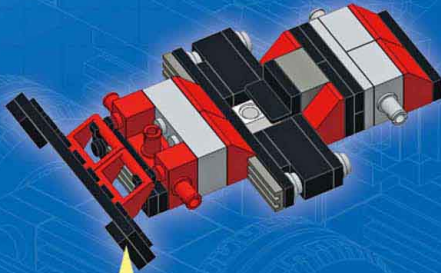

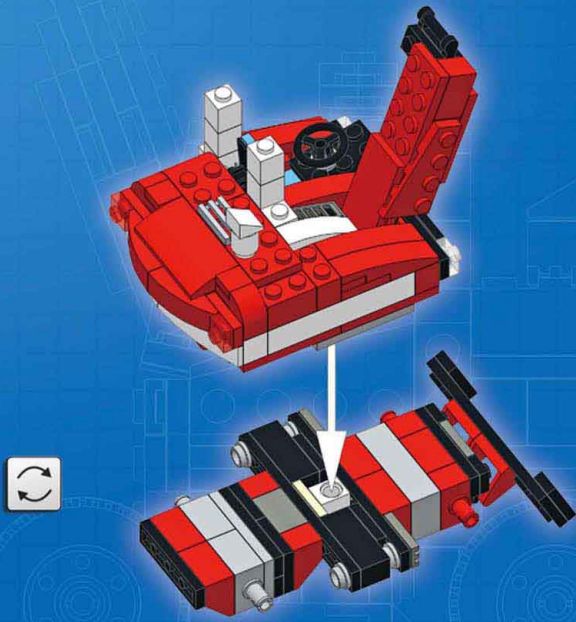



19

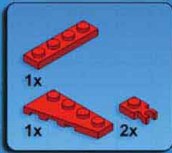

1

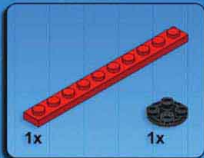
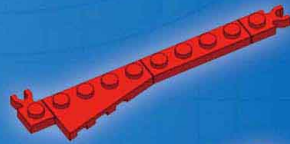

2

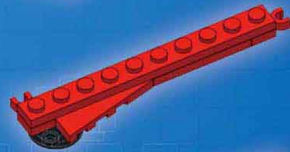

3

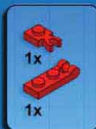
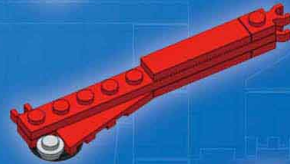

4

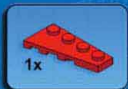
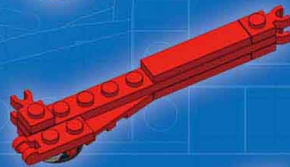

5

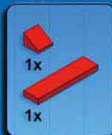
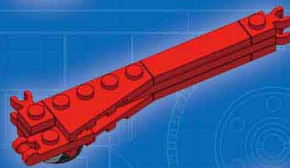

6



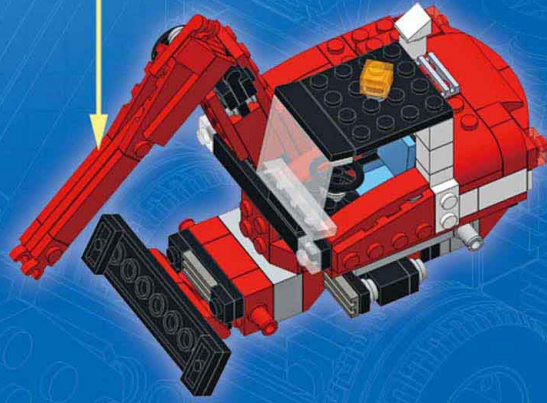
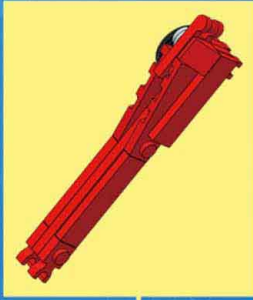



20



1

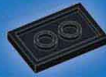

2



3

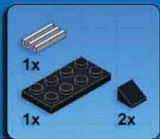
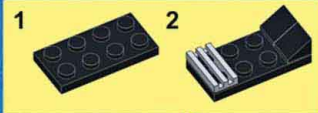

4



5



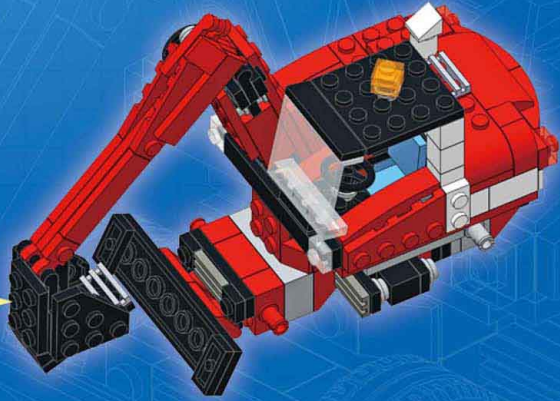



21

